

# ZINC ANODES CATALOGUE

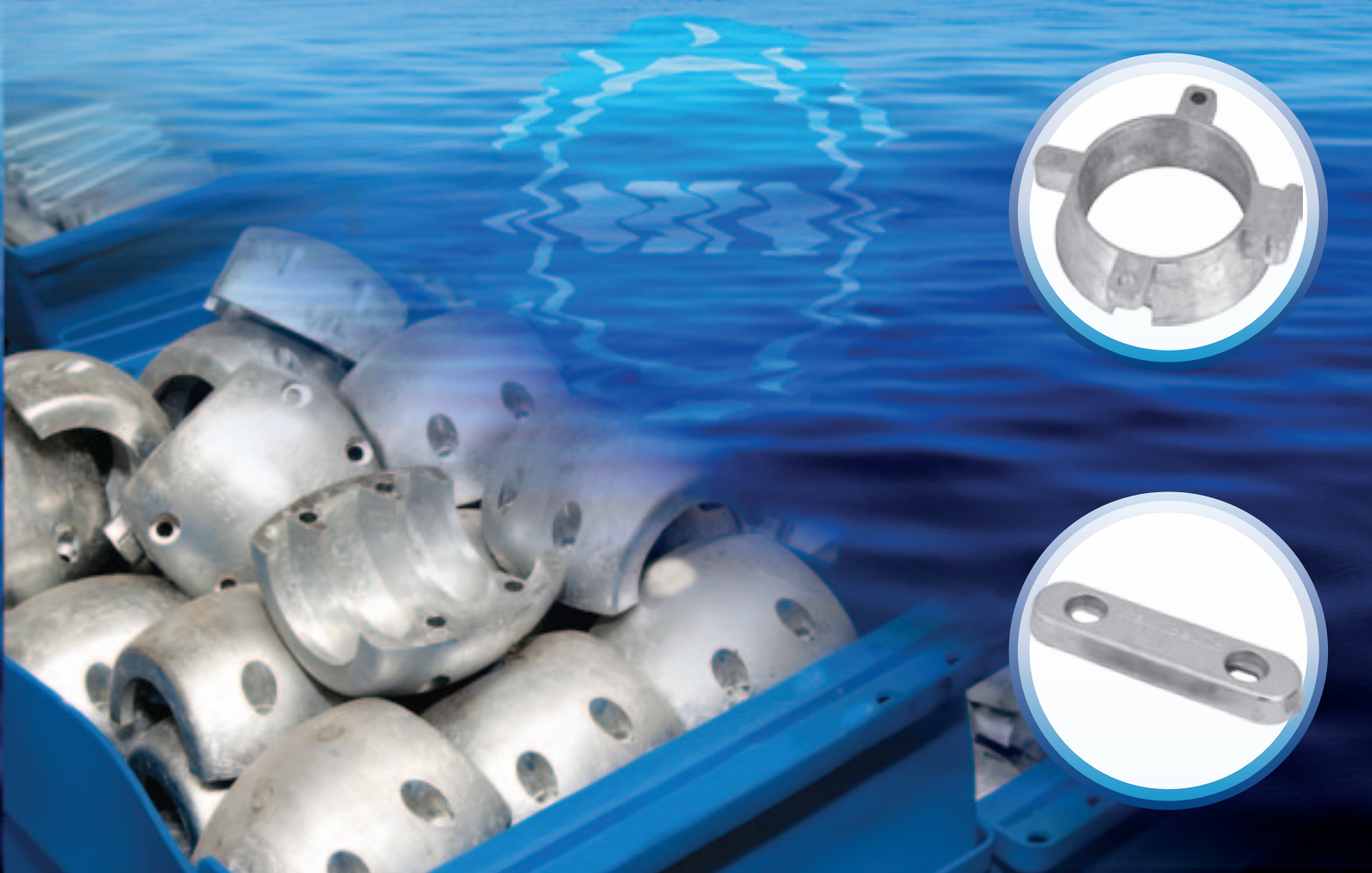

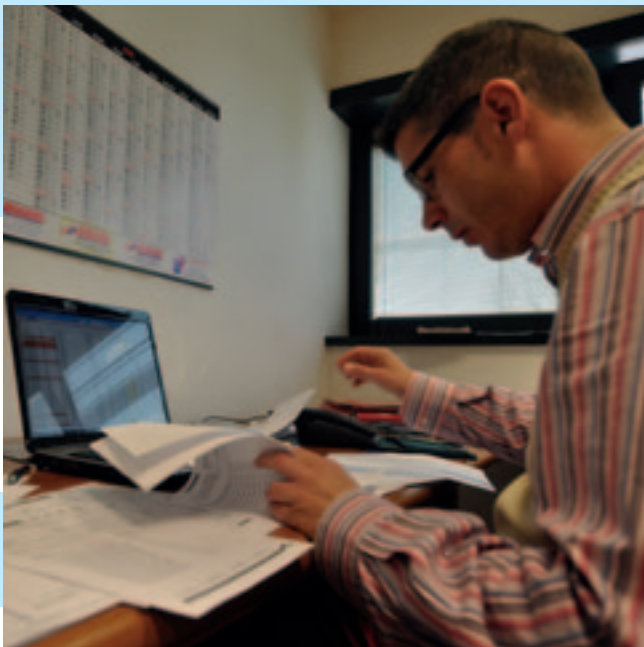

Experience our quality!



Factory

|   |           |
|---|-----------|
| <b>Volvo Penta.....</b>                     | <b>6</b>  |
| <b>Mercury Mercruiser .....</b>             | <b>10</b> |
| <b>Honda.....</b>                           | <b>14</b> |
| <b>Vetus .....</b>                          | <b>15</b> |
| <b>Yanmar .....</b>                         | <b>16</b> |
| <b>Bombardier-OMC-Johnson-Evinrude.....</b> | <b>17</b> |
| <b>Yamaha Mariner.....</b>                  | <b>20</b> |
| <b>Arneson .....</b>                        | <b>24</b> |
| <b>Hamilton .....</b>                       | <b>24</b> |
| <b>Gori .....</b>                           | <b>25</b> |
| <b>Bow thrust .....</b>                     | <b>26</b> |
| <b>Engine washers.....</b>                  | <b>27</b> |
| <b>Engine cooling system anodes.....</b>    | <b>29</b> |
| <b>Shafts anodes.....</b>                   | <b>32</b> |
| <b>Anodes for propellers.....</b>           | <b>34</b> |
| <b>Rudder anodes .....</b>                  | <b>37</b> |
| <b>Stern anodes .....</b>                   | <b>38</b> |
| <b>Flaps anodes.....</b>                    | <b>39</b> |
| <b>Bolt-on anodes .....</b>                 | <b>40</b> |
| <b>Weld-on anodes.....</b>                  | <b>42</b> |
| <b>Material composition .....</b>           | <b>43</b> |



cod. **OBVP-800703**

0.780 kg

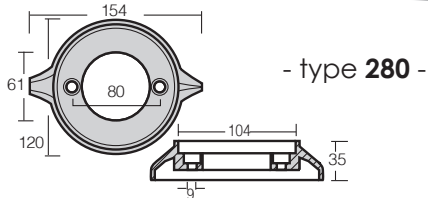

cod. **OBVP-800704**

0.510 kg

h35

cod. **OBVP-800704BIS**

0.472 kg

h30

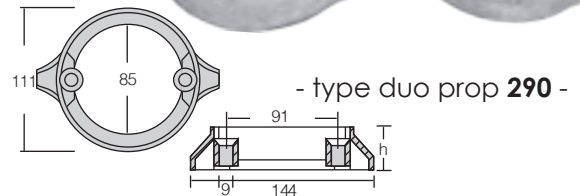

cod. **OBVP-800705**

0.895 kg

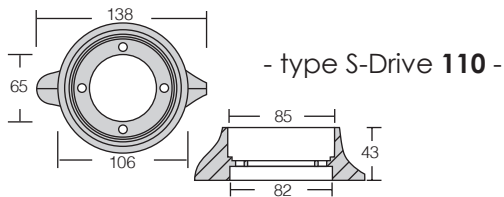

cod. **OBVP-800706**

0.485 kg

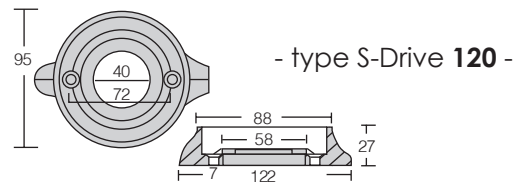
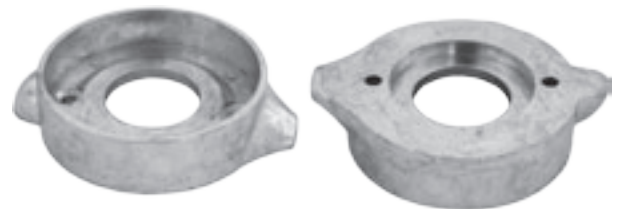

cod. **OBVP-800707**

0.895 kg

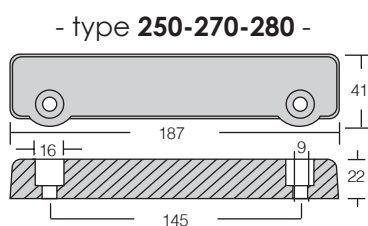

cod. **OBVP-800708**

0.800 kg

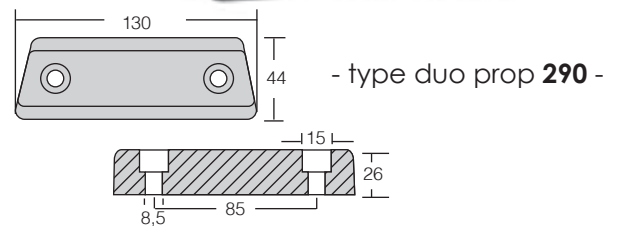

cod. **OBVP-800717**

0.120 kg

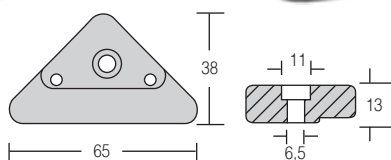

cod. **OBVP-800718**

1.040 kg

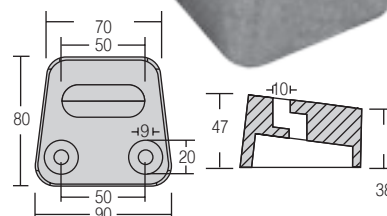
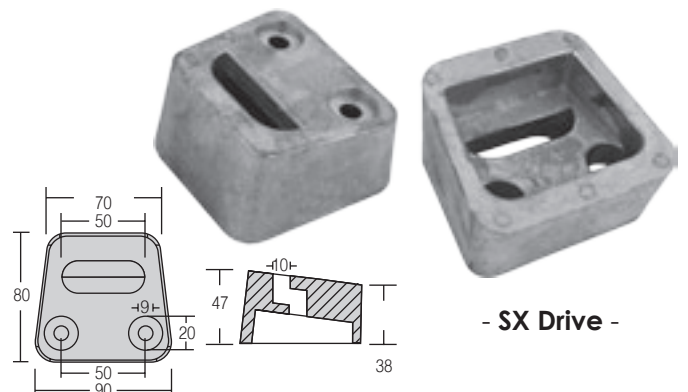

cod. **OBVP-800723**

0.200 kg

- type **DPX** -

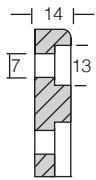
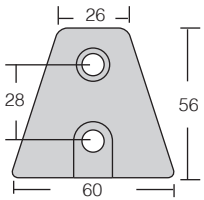

cod. **OBVP-800724**

0.764 kg

- type **DPX** -

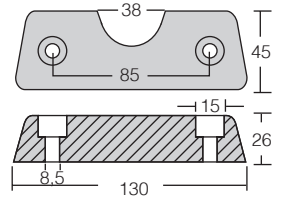

cod. **OBVP-800726**

0.850 kg

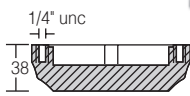
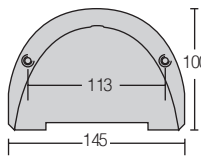
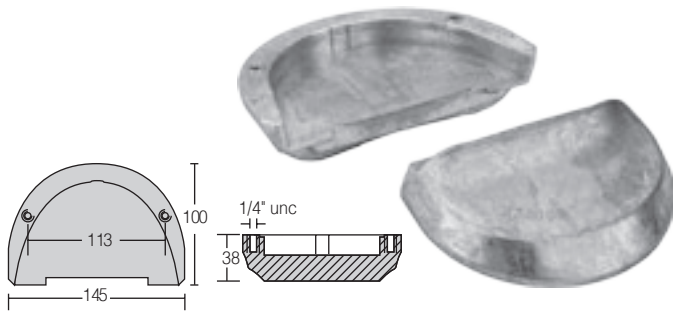

cod. **OBVP-800728**

0.264 kg

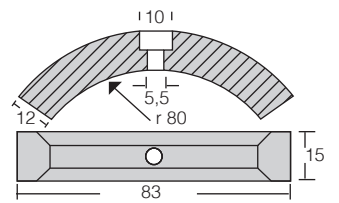

cod. **OBVP-800729**

0.041 kg

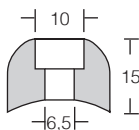
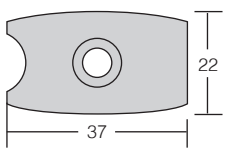

cod. **OBVP-800730**

0.043 kg

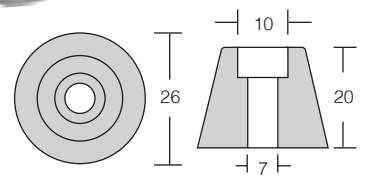

cod. **OBVP-800731**

0.053 kg

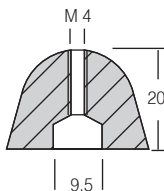
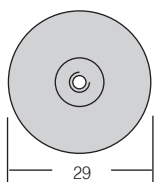

cod. **OBVP-800733**

0.870 kg

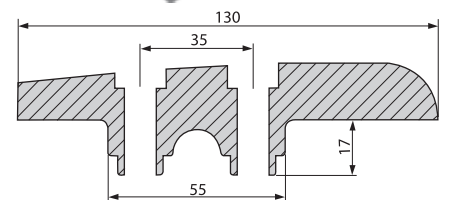
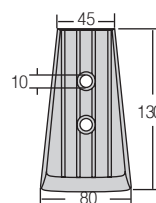

cod. **OBVP-800733BIS**

1.197 kg

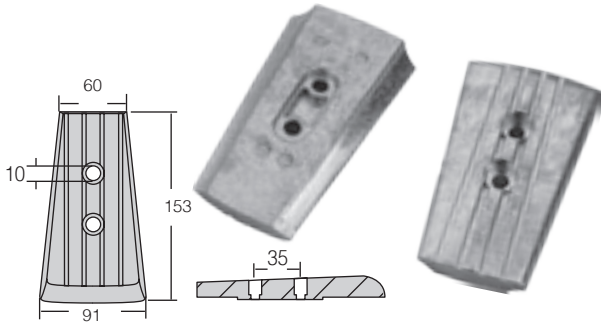

cod. **OBVP-800734**

1.460 kg

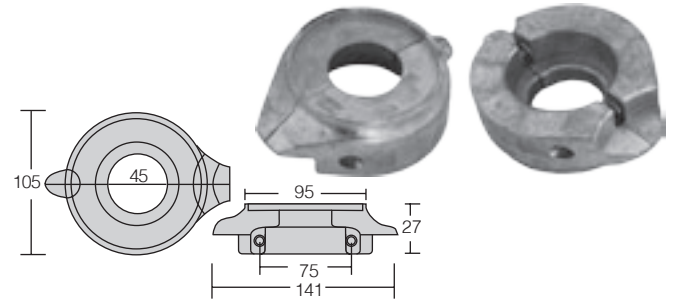

cod. **OBVP-800735**

0.473 kg

- type **du prop** -

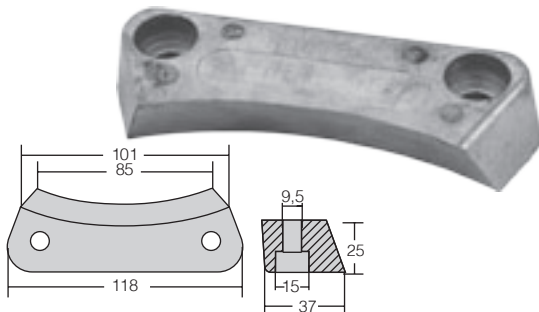

cod. **OBVP-800737**

1.045 kg

- type **SX-A, DPS-A** -

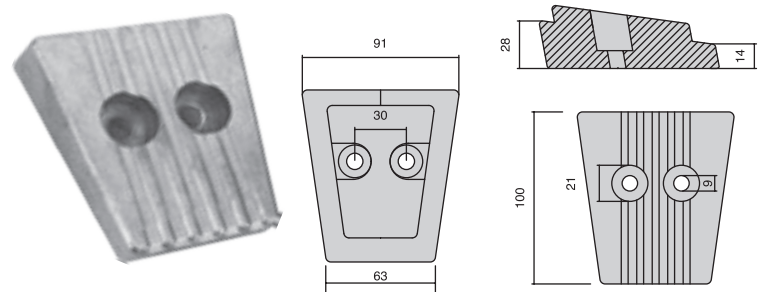

## Available on special request:

cod. **OBVP-800700**

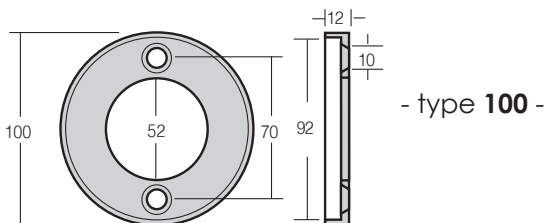

cod. **OBVP-800701**

- type **200** -

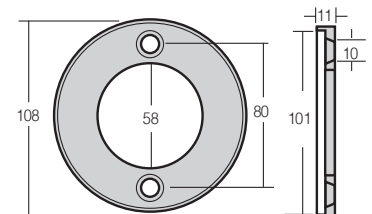

cod. **OBVP-800702**

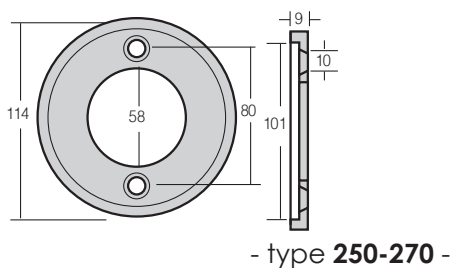

cod. **OBVP-800709**

- type **Trim 270** -

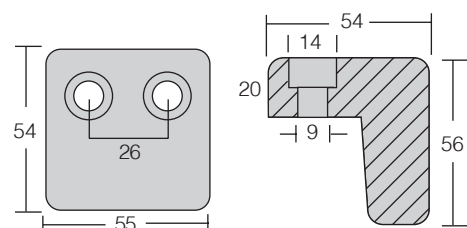

cod. **OBVP-800710**

- type **110/120** -

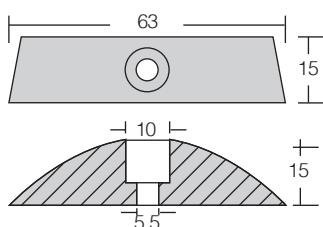

cod. **OBVP-800711**

- type **S Drive** -

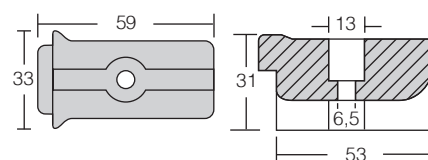



Available on special request:

cod. **OBVP-800712**

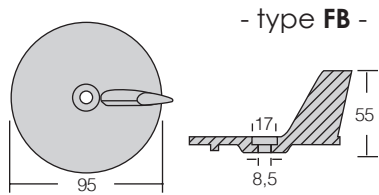

|                         | $\emptyset$ axis | $\emptyset 1$ | h  | $\emptyset$ | h1 |
|-------------------------|------------------|---------------|----|-------------|----|
| cod. <b>OBVP-800719</b> | 25/30            | 3/4"unc       | 70 | 37          | 33 |
| cod. <b>OBVP-800720</b> | 35               | 7/8"unc       | 70 | 37          | 33 |
| cod. <b>OBVP-800721</b> | 40               | 1"unc         | 80 | 47          | 35 |

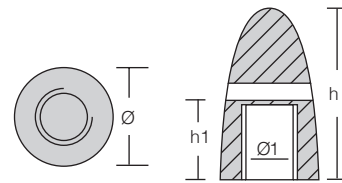

cod. **OBVP-800722**

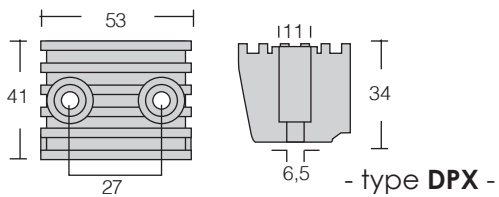

cod. **OBVP-800725**

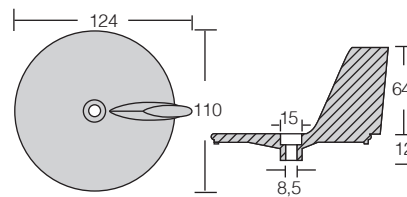

cod. **OBVP-800727**

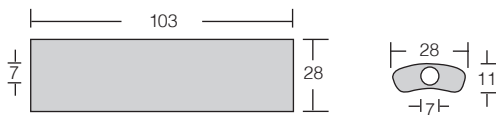

cod. **OBVP-800732**

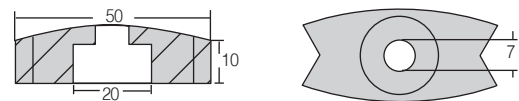

cod. **OBVP-800736**

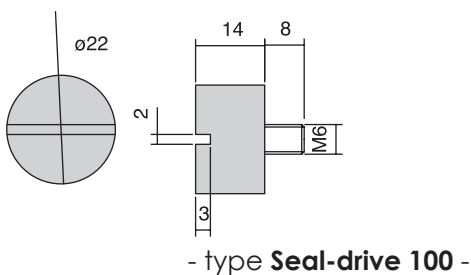

cod. **OBVP-800738**

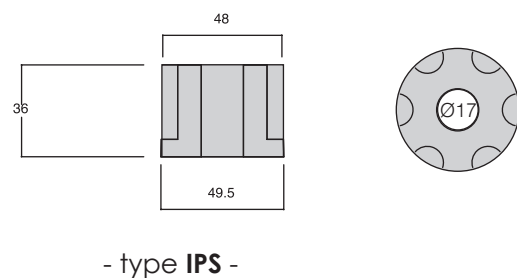

cod. **OBMM-800800** 7/16"unc 0.466 kg

- type **HP 50** -

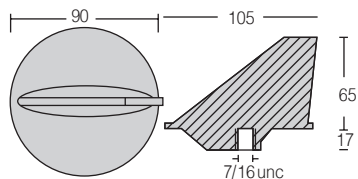

cod. **OBMM-800806**

0.924 kg



- type **Bravo/Alpha II generation/Mercuriser F.BB/E.B** -

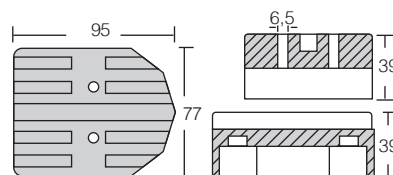

cod. **OBMM-800806BIS**

0.846 kg



- type **F.BB/E.B Mercuriser** -

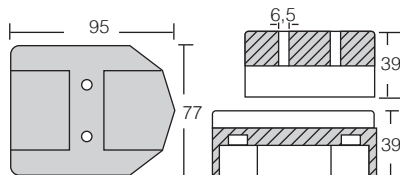

cod. **OBMM-800807** 1/2"unc

0.118 kg

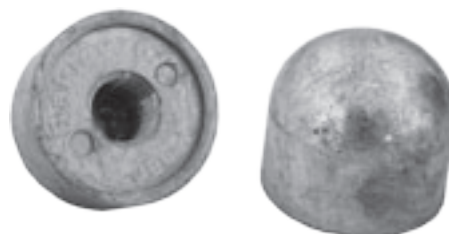

- type **Alpha One/Bravo One** -

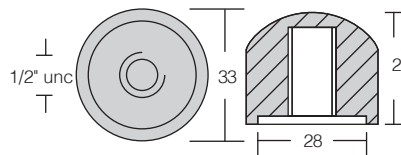

cod. **OBMM-800813**

\*Available on special request:

- type **HP 4.5** -

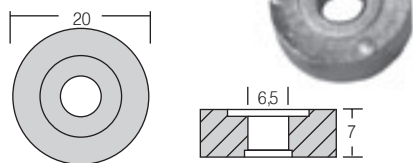

cod. **OBMM-800814**

0.809 kg

- type **Alpha I** -

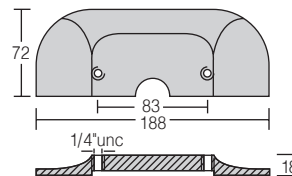

cod. **OBMM-800815**

0.920 kg

- type **Bravo** -

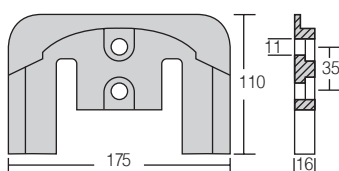

cod. **OBMM-800816**

0.585 kg

- type **HP 40 V6 135-150-175** -

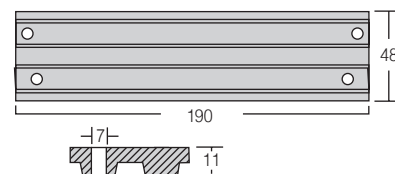
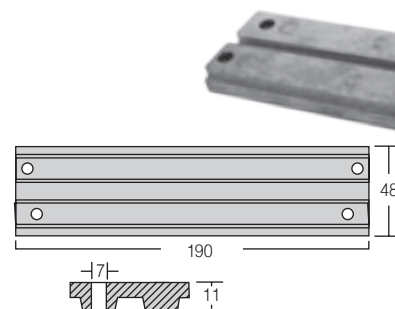

cod. **OBMM-800817**

0.113 kg

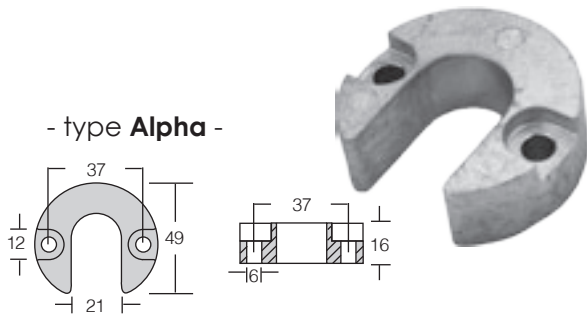

cod. **OBMM-800818**

0.337 kg

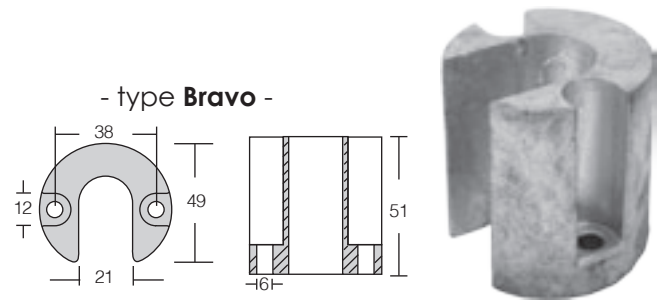

cod. **OBMM-800819**

0.222 kg

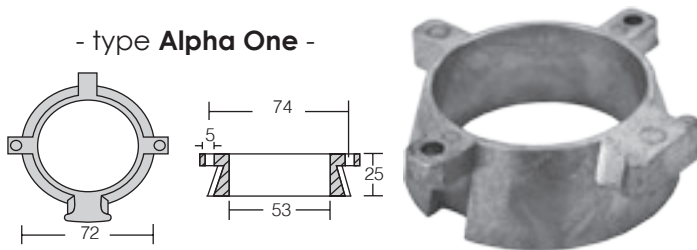

cod. **OBMM-800820**

0.311 kg

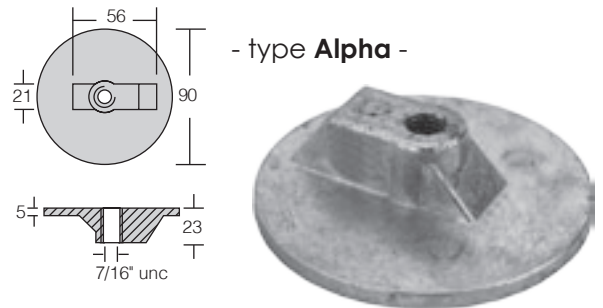

Ø 01 h kg

cod. **OBMM-80082320** 7.0 7.0 0.011

cod. **OBMM-80082424** 6.5 6.5 0.015



cod. **OBMM-800825** 0.239kg

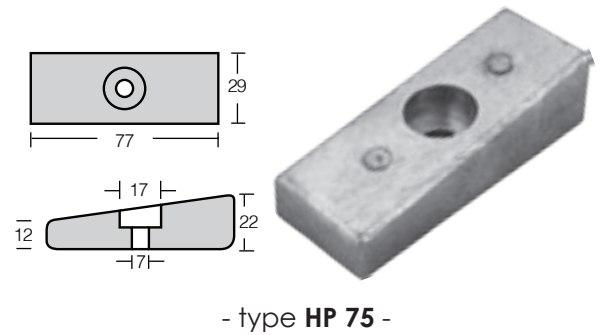

cod. **OBMM-800826**

Ø 112

0.316 kg

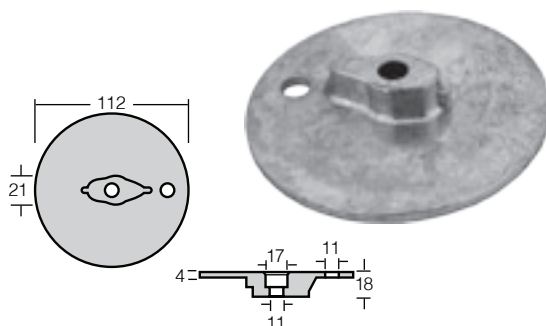

cod. **OBMM-800828**

0.167 kg

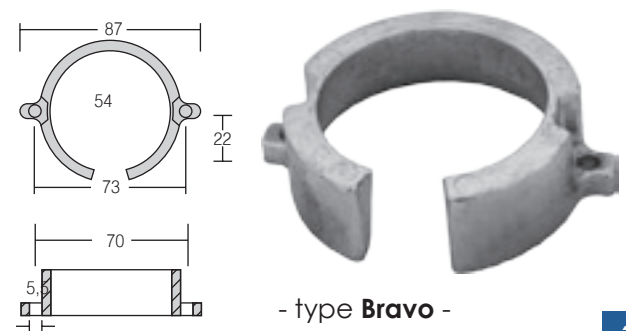

cod. **OBMM-800835**

0.290 kg

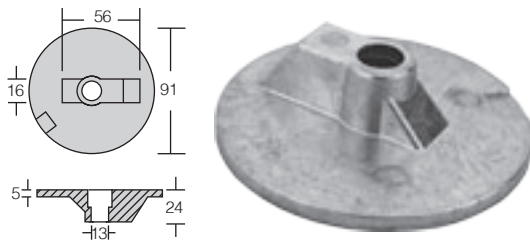

cod. **OBMM-800836**

0.508 kg



- type **Bravo 3** -

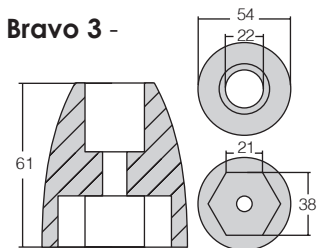

Available on special request:

cod. **OBMM-800801**

7/16"unc

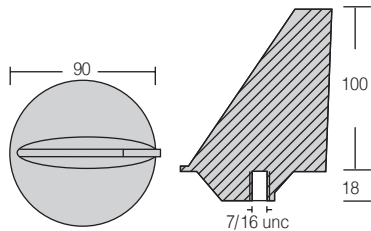

- type **HP 80-140** -

cod. **OBMM-800802**

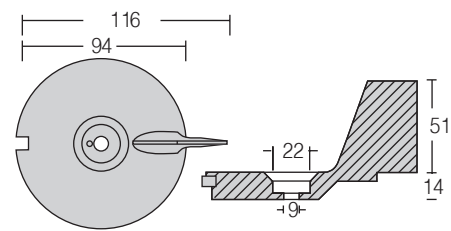

- type **HP 25** -

cod. **OBMM-800803**

5/16"unc

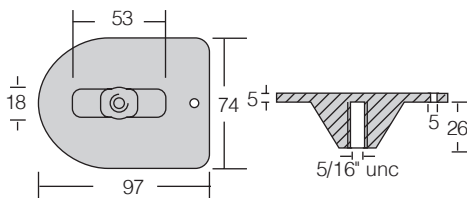

- type **HP 20** -

cod. **OBMM-800804**

7/16"unc

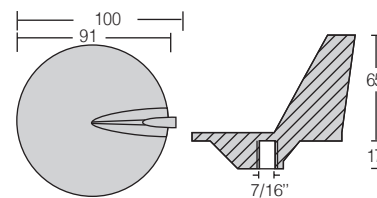

- type **HP 50-140** -

cod. **OBMM-800805**

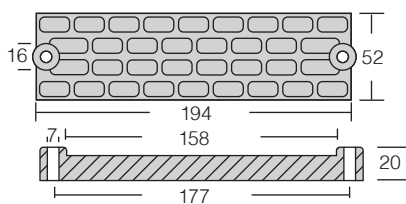

- type **HP 25/50/60/75 (Mercury)**  
**HP 90-100 (Mercuriser E.B.) HP 80-115 (Super America)** -

cod. **OBMM-800808**

64 x 64 x 10OBMM

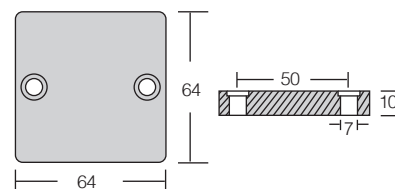

cod. **OBMM-800809**

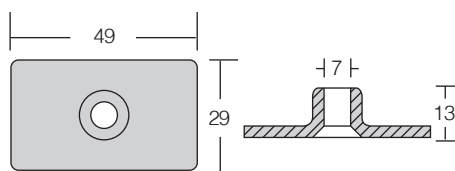

- type **HP 4.5-9 (Mercury)**-

cod. **OBMM-800810**

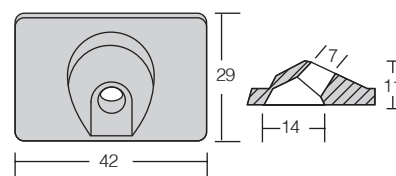

- type **HP 6-9.9 (Mercury)**-

Available on special request:

cod. OBMM-800811

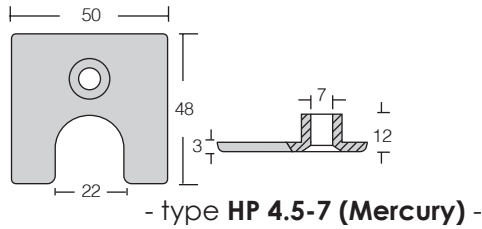

cod. OBMM-800812

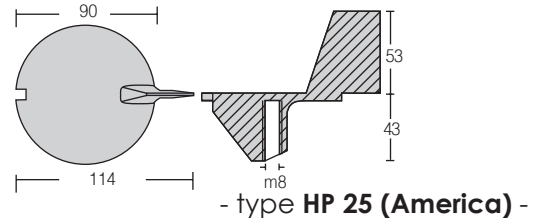

cod. OBMM-800821

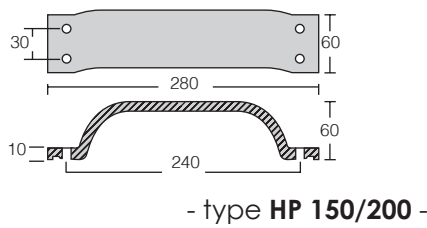

cod. OBMM-800822

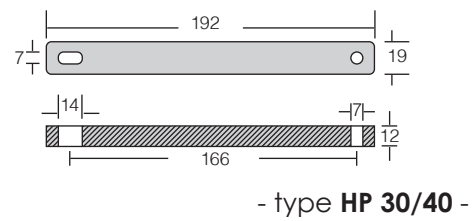

cod. OBMM-800827

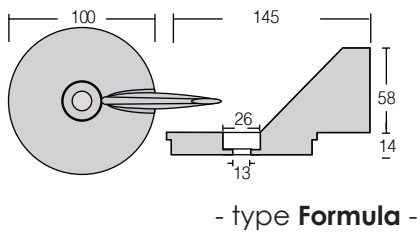

cod. OBMM-800829

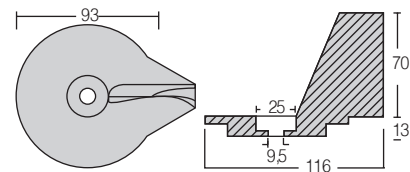

cod. OBMM-800830 7/16"unc

cod. OBMM-800831 1:43 Ø 8

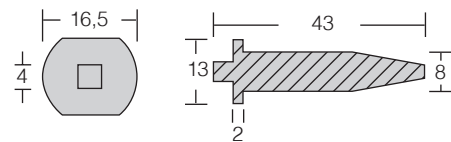
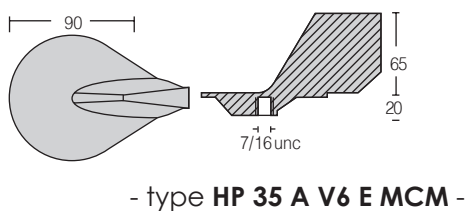

cod. OBMM-800832

cod. OBMM-800833

cod. OBMM-800834

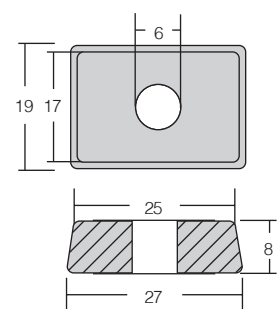
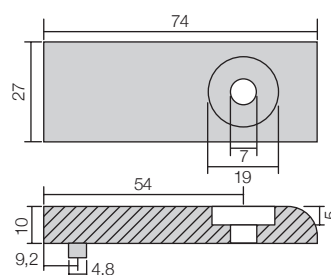
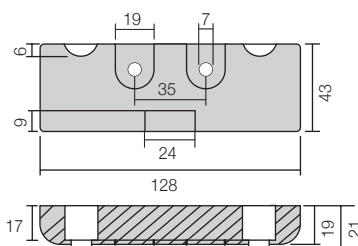

- type HP 215-275 Verado -

- type HP 215-275 -



cod. **OBHN-801401**

0.079 kg

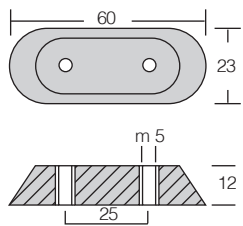

- type **HP 8-20 FB** -

cod. **OBHN-801407**

0.218 kg

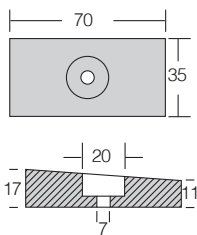

- type **HP 75-130-225** -

cod. **OBHN-801410**

0.395 kg



- type **HP 8-10-15** -

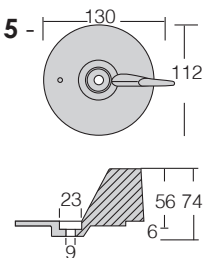

## Available on special request:

cod. **OBHN-801402**

- type **HP 10-50** -

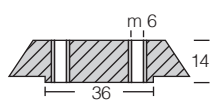
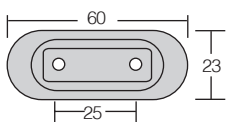

cod. **OBHN-801403**

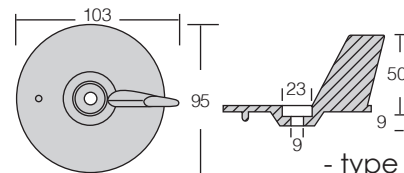

- type **HP 25-40-50** -

cod. **OBHN-801404**

- type **HP 40-50** -

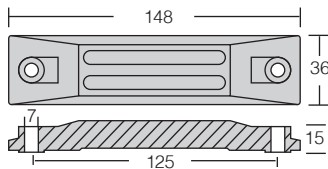

cod. **OBHN-801406**

- type **HP 75-130-225** -

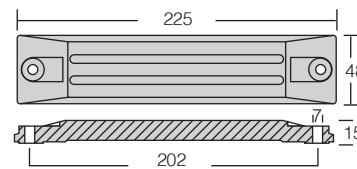

cod. **OBHN-801409**

32 x 28

h 10/8

- type **HP 8-10-15** -

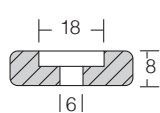
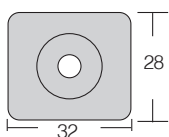

cod. **OBHN-801405**

- type **HP 75-130** -

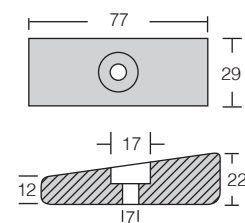

cod. **OBVT-803500**

0.420 kg

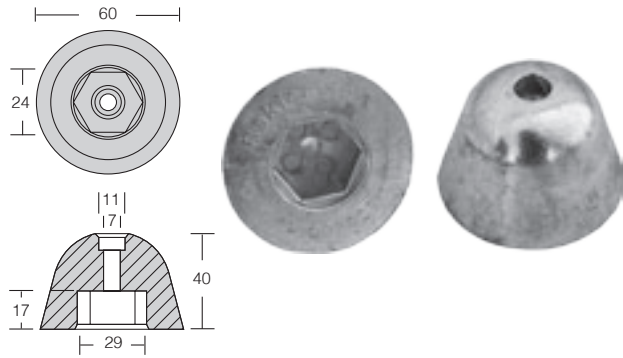

cod. **OBVT-803502**

0.062 kg

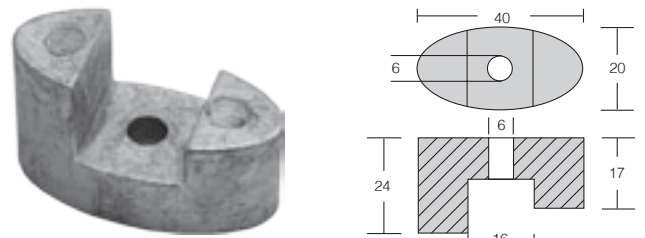

cod. **OBVT-803508**

0.369 kg

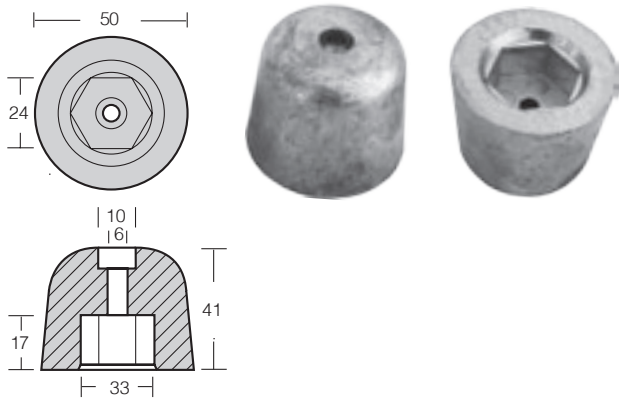

cod. **OBVT-803509**

0.380 kg

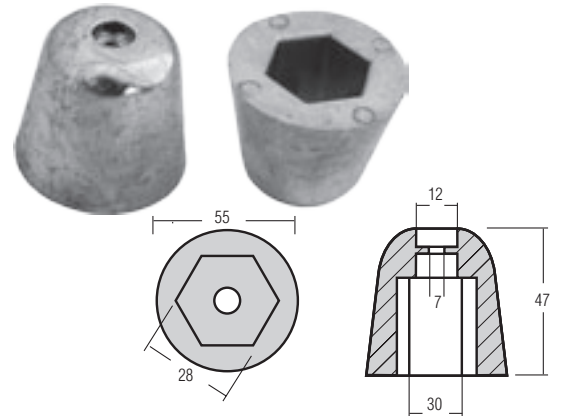

cod. **OBVT-803501**

Ø1- 56

h55

Ø-68

Ø2- 6.5

0.635 kg

**\*Available on special request:**

cod. **OBVT-803504**

Ø1- 56

h52

Ø-84

Ø2- 6.5

0.945 kg

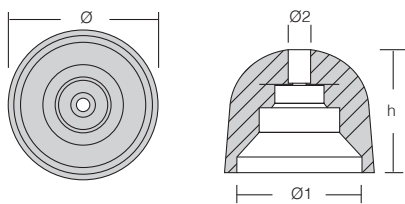

cod. **OBYM-801300** l-40 Ø1-30 Ø2-8x1.25 0.157 kg

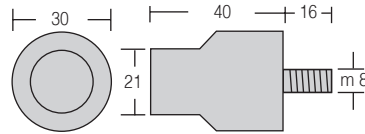

- type **HP 8-10** -

cod. **OBYM-801301** l-30 Ø1-20 Ø2-8x1.25 0.066 kg

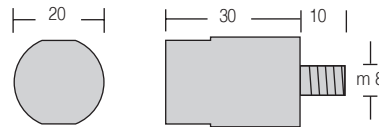

- type **HP 8-12** -

cod. **OBYM-801305** 0.745 kg

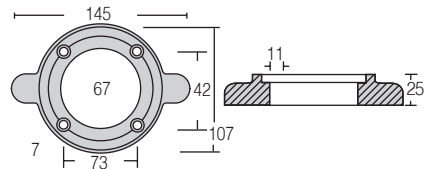

- type **collar** -

**Available on special request:**

cod. **OBYM-801304**

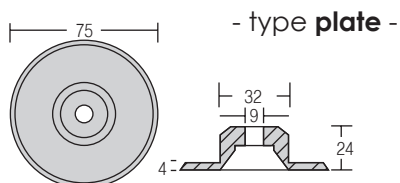

- type **plate** -

cod. **OBBMR-800905**

0.466 kg

- type **HP 55 F.B/E.B (OMC)** -

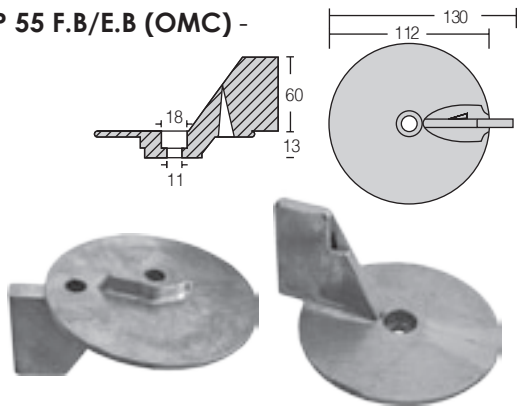

cod. **OBBMR-800909**

0.574 kg

- type **HP 50-75** -

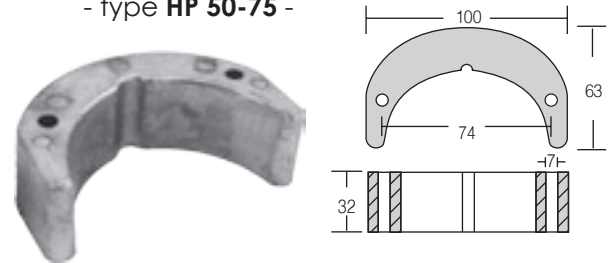

cod. **OBBMR-800912**

\*Available on special request:

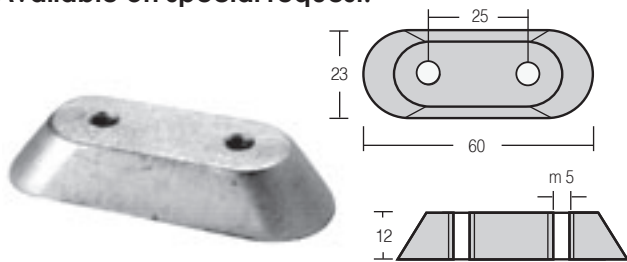

- type **HP 2-150 (Johnson)** -

cod. **OBBMR-800915**

0.188 kg

- type **737 Johnson** -

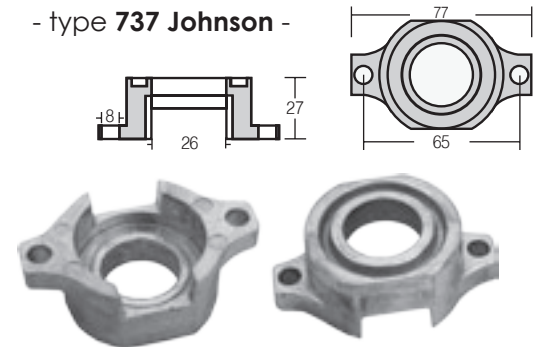

cod. **OBBMR-800922**

1.040 kg

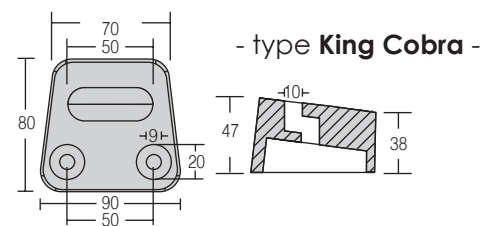

- type **King Cobra** -

**Available on special request**

cod. **OBBMR-800900**

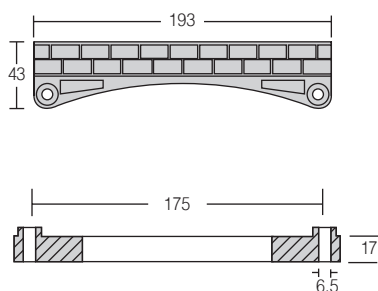

- type **OMC P** -

cod. **OBBMR-800901**

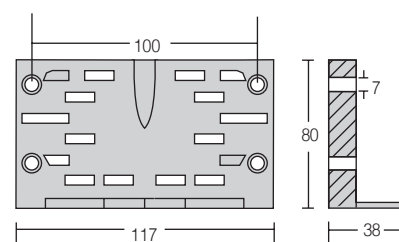

- type **HP 100-245 OMC M** -

Available on special request:

cod. **OBBMR-800902**

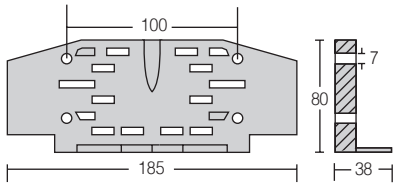

- type **HP 100-245 OMC G** -

cod. **OBBMR-800904**

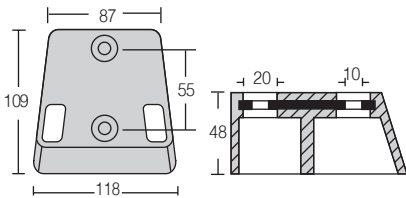

- type **HP 130-385 COBRA (OMC)** -

cod. **OBBMR-800907**

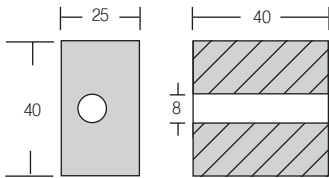

- type **HP 50-140-200 (Evinrude), 50-115-120-140 (Johnson), 70-90-140 (OMC)**

cod. **OBBMR-800910**

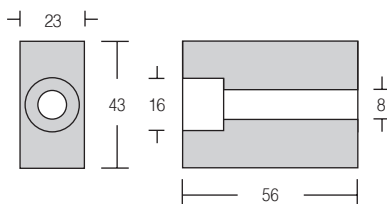

- type **HP 160-280 (Johnson), V4/V6 (Evinrude)** -

cod. **OBBMR-800913**

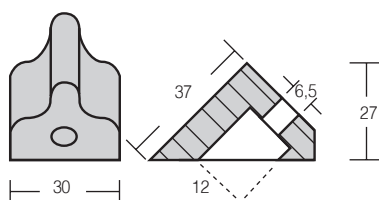

- type **HP 4-7.5 (Johnson, Evinrude)** -

cod. **OBBMR-800903**

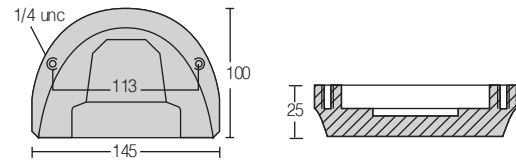

- type **COBRA (OMC)** -

cod. **OBBMR-800906**

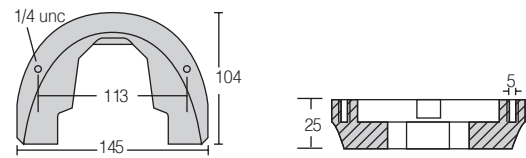

- type **HP 90 (OMC)** -

cod. **OBBMR-800908**

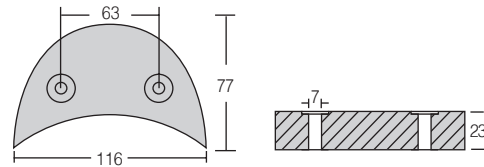

- type **HP 90-140 (OMC, Evinrude, Johnson)** -

cod. **OBBMR-800911**

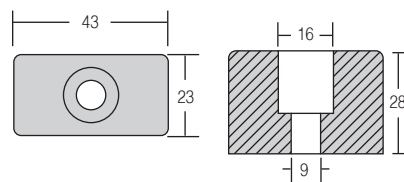

- type **COBRA (OMC)** -

cod. **OBBMR-800914**

cod. **OBBMR-800914/1**

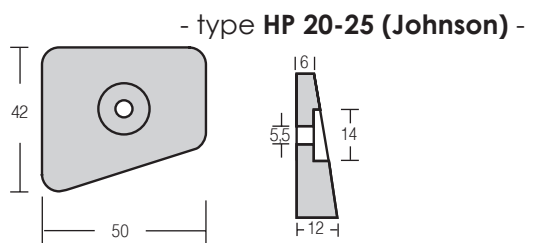

- type **HP 20-25 (Johnson)** -



**Available on special request:**

cod. **OBBMR-800916**

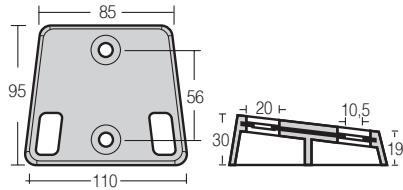

- type **COBRA** -

cod. **OBBMR-800917**

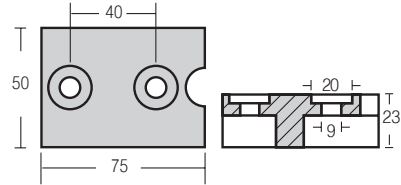

- type **HP 70-120 (Johnson/Evinrude Diabolo)** -

cod. **OBBMR-800918**

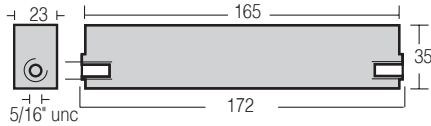

- type **HP 60-175 (Johnson/Evinrude)** -

cod. **OBBMR-800919**

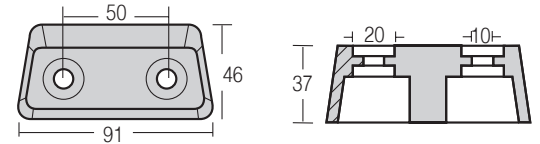

- type **COBRA OMC** -

cod. **OBBMR-800920**

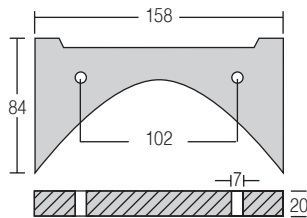

- type **COBRA 5700** -

cod. **OBBMR-800921**

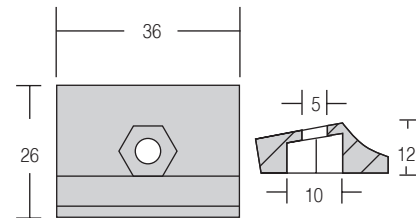

- type **HP 9-15 (Johnson)** -

cod. **OBBMR-800923**

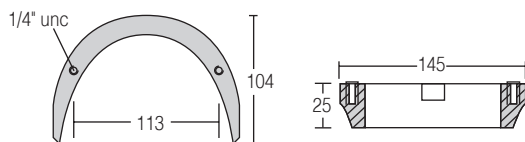

- type **HP 225** -

cod. **OBBMR-800925**

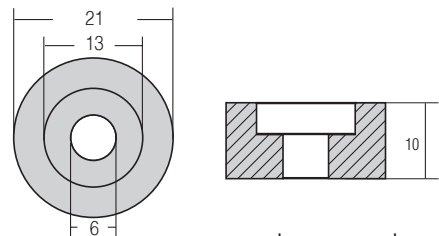

- type **washer** -

cod. **OBBMR-800926**

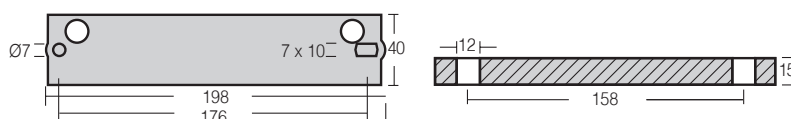

cod. **OBYMH-801100**

0.210 kg

- type **HP 20-25-30 Yamaha, 10-50 Mariner** -

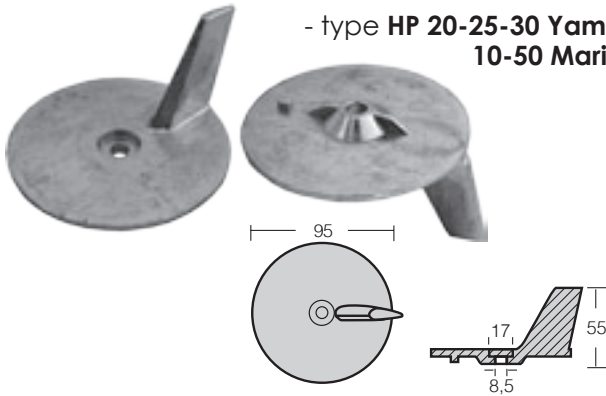

cod. **OBYMH-801112**

0.920 kg

- type **HP 150/200** -

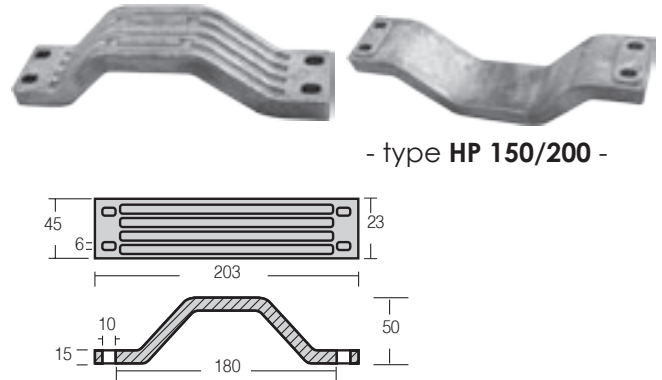

cod. **OBYMH-801113**

0.568 kg

- type **HP 60-90** -

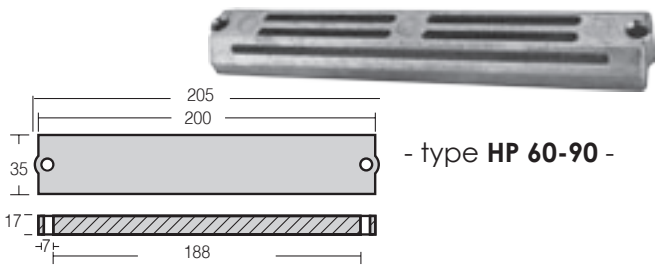

cod. **OBYMH-801123**

0.106 kg

- type **HP 40** -

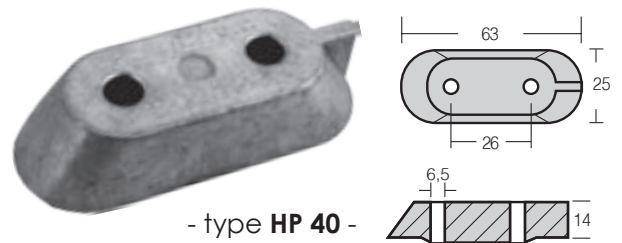

cod. **OBYMH-801140**

0.391 kg

- type **4T 80-100** -

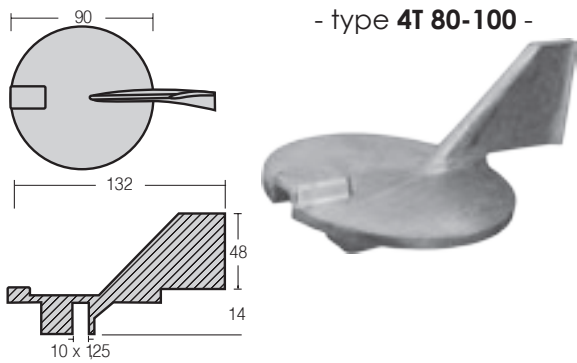

cod. **OBYMH-801141**

0.215 kg

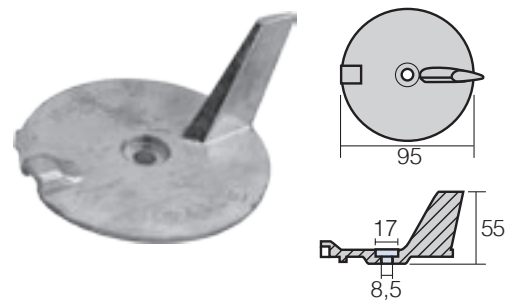

**Available on special request:**

cod. **OBYMH-801101**

- type **Mariner HP 40/60, Yamaha HP 55** -

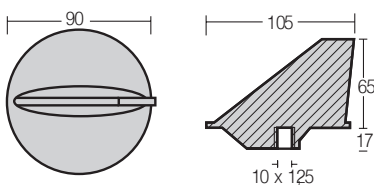

cod. **OBYMH-801102**

- type **HP 80-140 (Mariner)** -

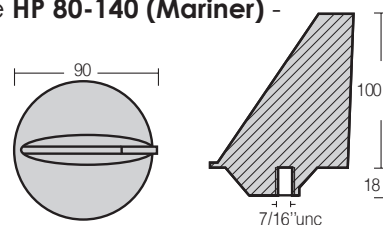

Available on special request:

cod. OBYMH-801103

- type HP 155-225 V4-V6 (Yamaha) -

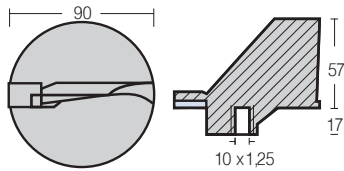

cod. OBYMH-801104

- type HP 60-90 (Yamaha) -

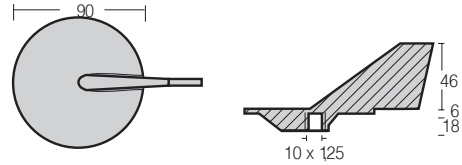

cod. OBYMH-801105

- type HP 155-225 (Yamaha) -

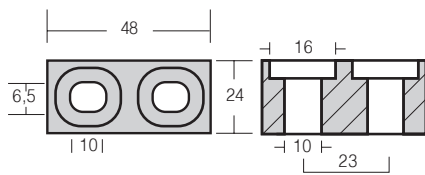

cod. OBYMH-801106

- type HP 9.9 (Yamaha) -

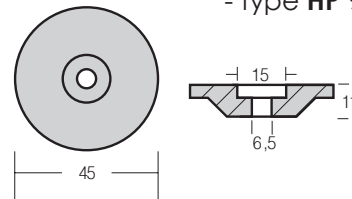

cod. OBYMH-801107

- type HP 6-9.9 (Yamaha) -

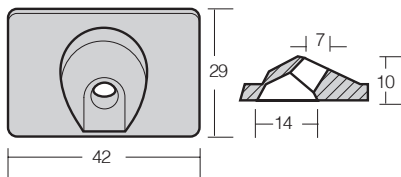

cod. OBYMH-801108

- type HP 6-8 (Yamaha) -

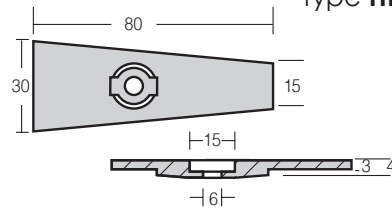

cod. OBYMH-801114

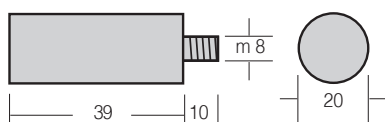

cod. OBYMH-801115

- type Yamaha -

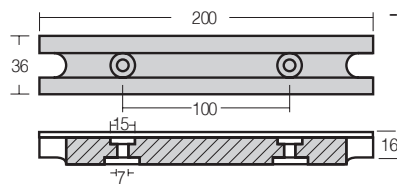

cod. OBYMH-801116

- type HP 9.9-15 (Yamaha) -

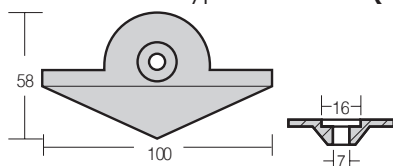

cod. OBYMH-801117

- type HP 3.5 (Yamaha) -

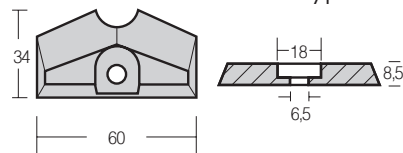

cod. OBYMH-801118

- type 6C-6D-8C (Yamaha) -

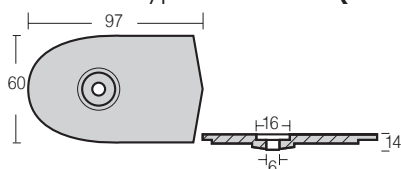

cod. OBYMH-801119

- type HP 130/260 -

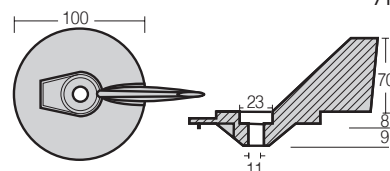

**Available on special request:**

cod. **OBYMH-801120**

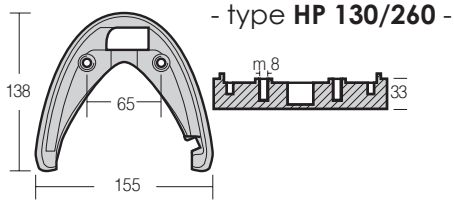

cod. **OBYMH-801122**

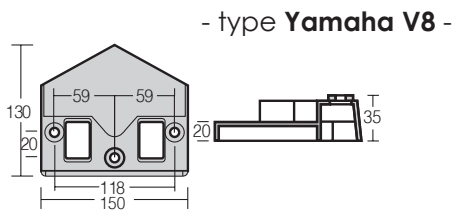

cod. **OBYMH-801125**

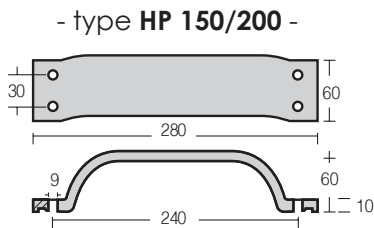

cod. **OBYMH-801130**

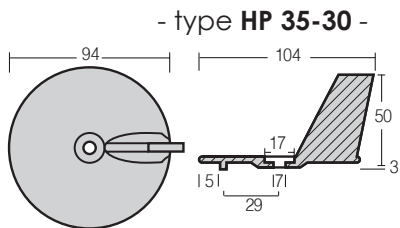

cod. **OBYMH-801132**

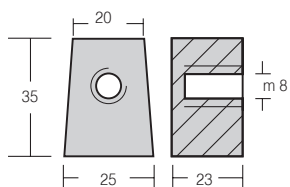

cod. **OBYMH-801135**

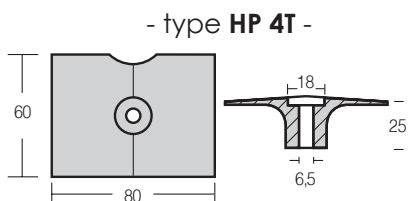

cod. **OBYMH-801121**

- type **H25-H8 (Mariner), W30-W8 (Yamaha)** -

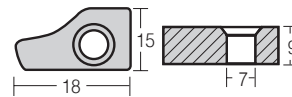

cod. **OBYMH-801124**

- type **Yamaha V8** -

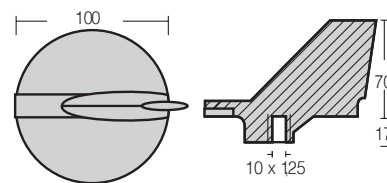

cod. **OBYMH-801126**

- type **HP 30/40** -

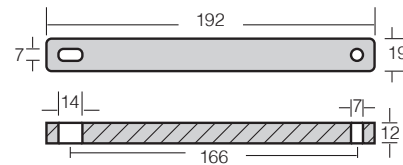

cod. **OBYMH-801131**

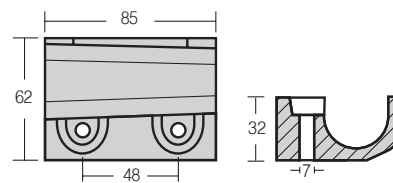

cod. **OBYMH-801133**

cod. **OBYMH-801134**

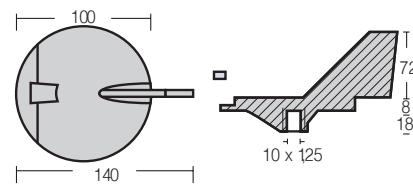

cod. **OBYMH-801136**

- type **HP 909** -

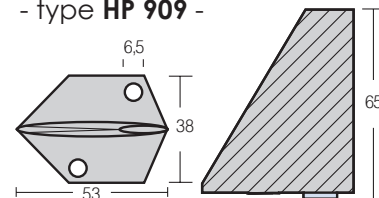

Available on special request:

cod. OBYMH-801137

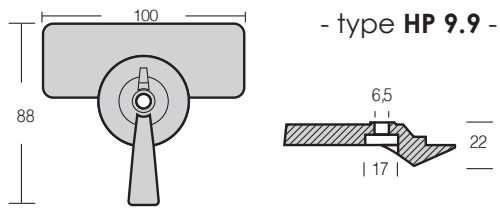

cod. OBYMH-801138

- type HP Yamaha TD -

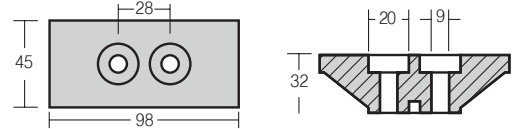

cod. OBYMH-801139

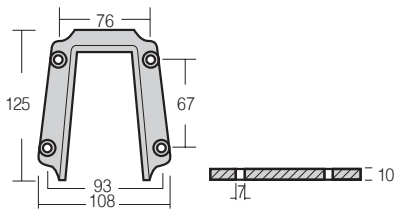

cod. OBYMH-801142

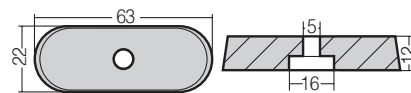

cod. OBYMH-801143

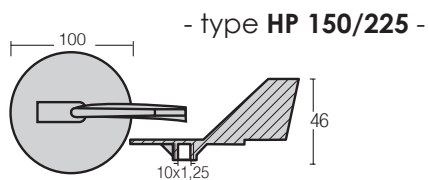

cod. OBYMH-801144

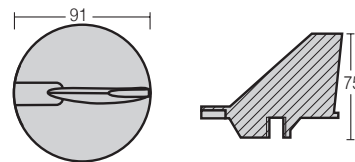

cod. OBYMH-801145

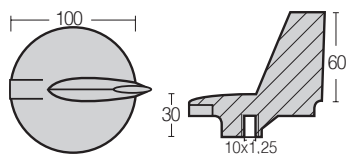

cod. OBYMH-801146

- type HP 80/100 -

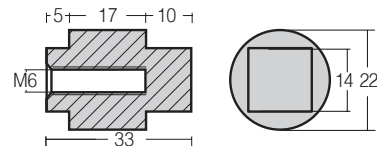

cod. OBYMH-801147

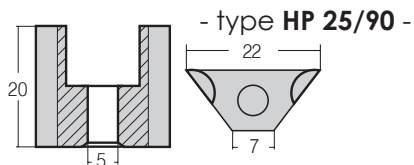

cod. OBYMH-801149

- type HP 40/200 -

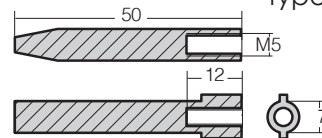

cod. OBYMH-801150

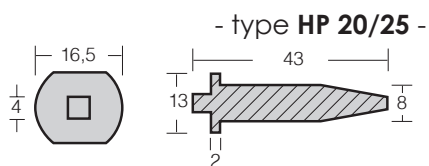

cod. OBYMH-801151

- type HP 9.9 -

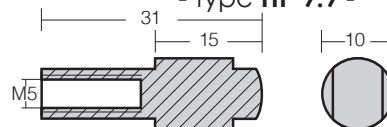

cod. OBYMH-801152

- type HP 100/225 -

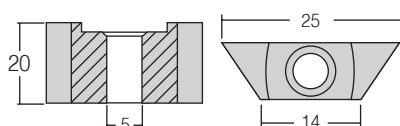

cod. OBYMH-801153

- type HP 60/225 -

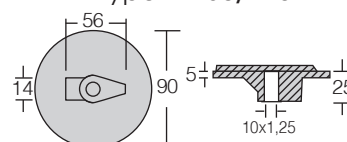



cod. **OBARN-802510**

1.370 kg

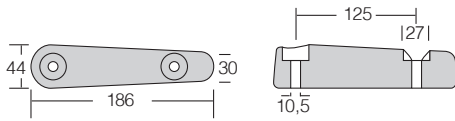

**Available on special request:**

cod. **OBARN-802511**

cod. **OBARN-802512**

cod. **OBARN-802513**

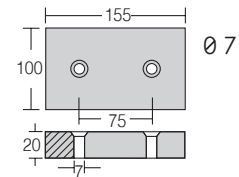
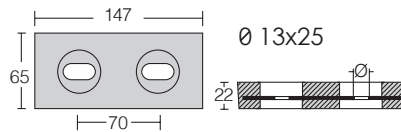
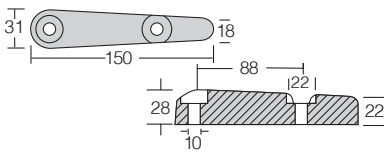

**HAMILTON**

cod. **OBHMT-802521**

0.289 kg

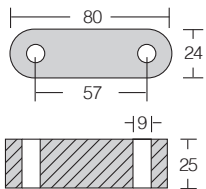

cod. **OBHMT-802523**

1.024 kg

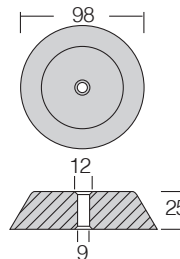

**Available on special request:**

cod. **OBHMT-802520**

cod. **OBHMT-802524**

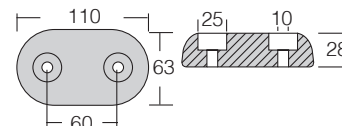
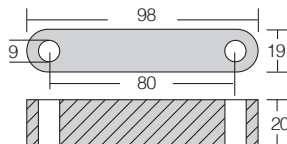

cod. **OBHMT-802525**

cod. **OBHMT-802526**

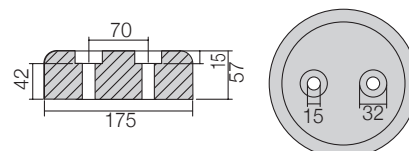
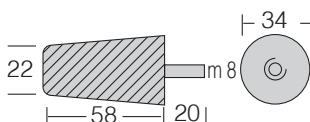

Available on special request:

cod. **OBGR-801000**

Ø helix 22"-26"

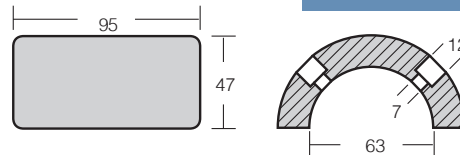

|                         | l  | Ø | h  | Ø helix   |
|-------------------------|----|---|----|-----------|
| cod. <b>OBGR-801001</b> | 33 | 8 | 20 | 22"-26"   |
| cod. <b>OBGR-801002</b> | 26 | 8 | 16 | 15"-16.5" |
| cod. <b>OBGR-801003</b> | 28 | 6 | 16 | 18"-20"   |

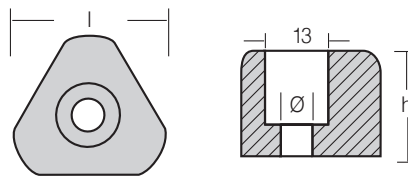

|                         | l  | Ø | h | Ø helix |
|-------------------------|----|---|---|---------|
| cod. <b>OBGR-801004</b> | 44 | 6 | 3 | 28"-30" |

cod. **OBGR-801005**

Ø helix 28"-30"

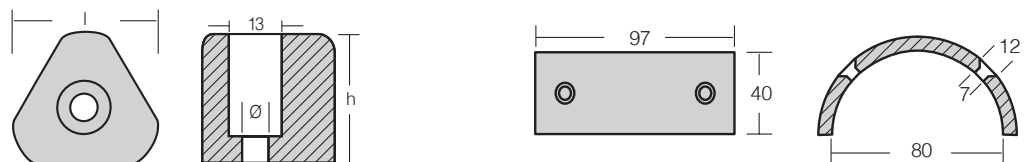

cod. **OBGR-801006** h34 Ø helix 18"-20"

cod. **OBGR-801008** h40 Ø helix 18"-20"

cod. **OBGR-801007** h24 Ø helix 15"-16.5"

cod. **OBGR-801009** h50 Ø helix 28"-30"

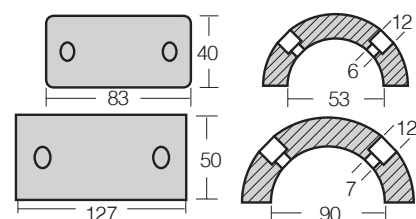
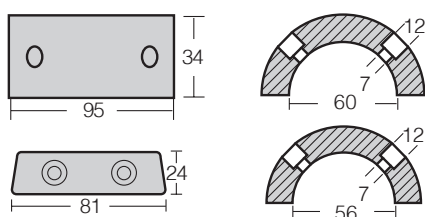

cod. **OBTR-801050**

0.043 kg

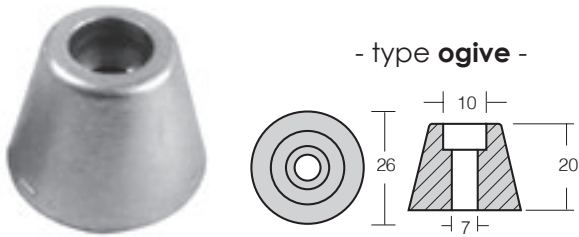

cod. **OBTR-801051**

0.171 kg

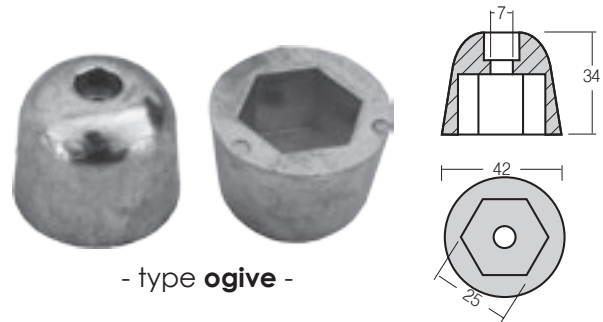

cod. **OBTR-801052**

0.123 kg

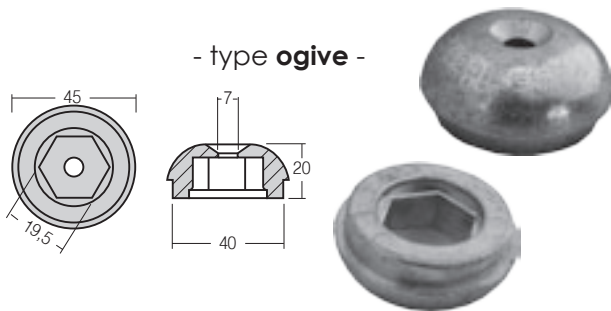

cod. **OBTR-803505**

0.041 kg

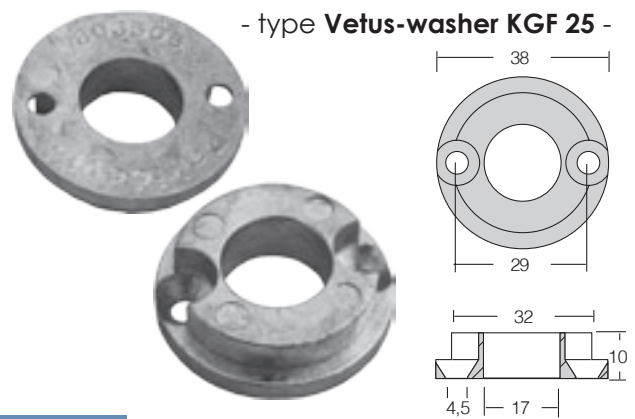

cod. **OBTR-803506**

0.149 kg



## Available on special request:

cod. **OBTR-803507**

- type **Vetus-washer KGF 75** -

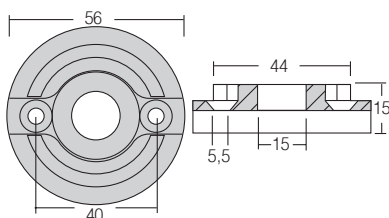

cod. **OBTR-802480**

- type **slide power** -

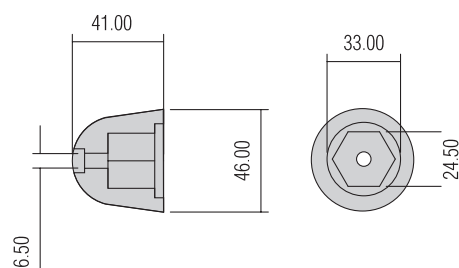

cod. **OBCST-802403/1**

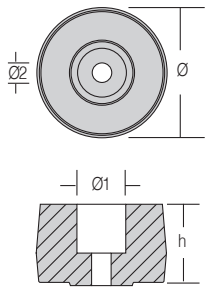

| Ø  | Ø1 | Ø2 | h  | kg    |
|----|----|----|----|-------|
| 57 | 26 | 10 | 35 | 0.488 |

\*other measures on special request



- type **Castoldi** -

cod. **OBVT-803503**

| h  | Ø  | kg    |
|----|----|-------|
| 45 | 78 | 0.971 |



- type **Vetus** -

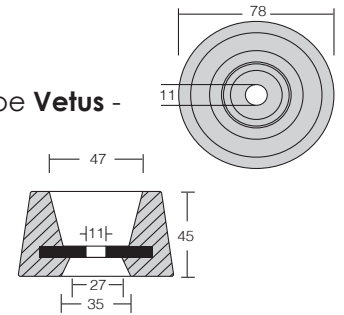

## Available on special request:

|                          | Ø  | h | Ø1  | Ø2 |
|--------------------------|----|---|-----|----|
| cod. <b>OBYMH-801127</b> | 20 | 7 | 6.5 | 8  |

|                          |    |     |     |   |
|--------------------------|----|-----|-----|---|
| cod. <b>OBYMH-801128</b> | 24 | 6.5 | 6.5 | 8 |
|--------------------------|----|-----|-----|---|

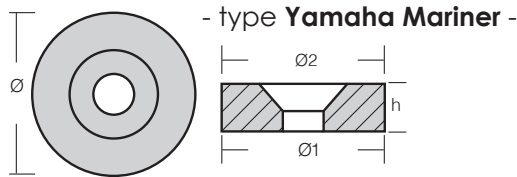

- type **Yamaha Mariner** -

cod. **OBYM-801302**

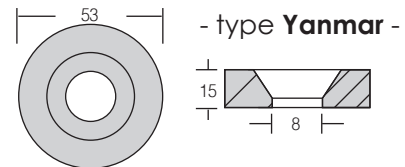

- type **Yanmar** -

cod. **OBHN-801408**

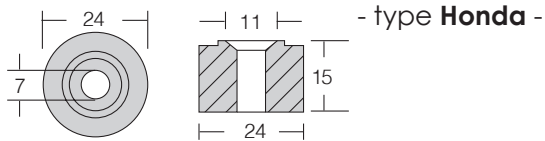

- type **Honda** -

cod. **OBYMH-801109**

cod. **OBYMH-801110**

cod. **OBYMH-801111**

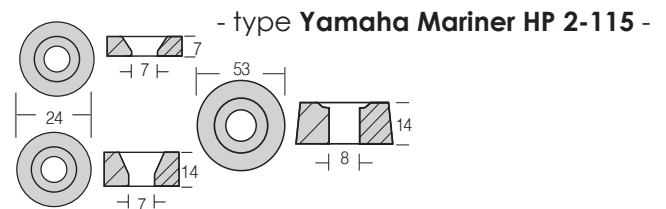

- type **Yamaha Mariner HP 2-115** -

cod. **OBYMH-801148**

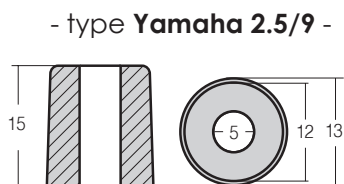

- type **Yamaha 2.5/9** -

cod. **OBSZ-801205**

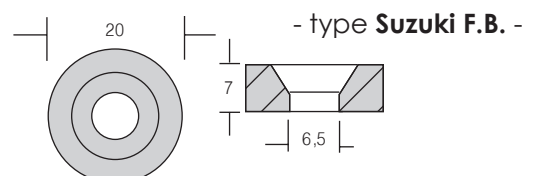

- type **Suzuki F.B.** -

**Available on special request:**

cod. **OBTHT-801250**

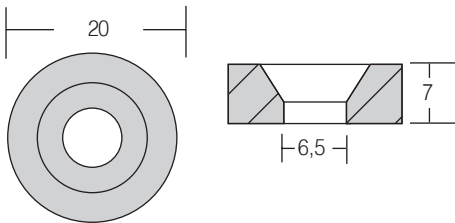

- type **Tohatsu HP 2.5-3-5-6-8** -

cod. **OBTHT-801251**

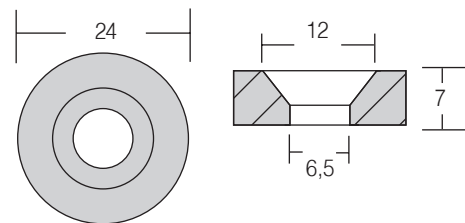

- type **Tohatsu 15/18 Maxi, 25-40 Corsa** -

cod. **OBHN-801400**

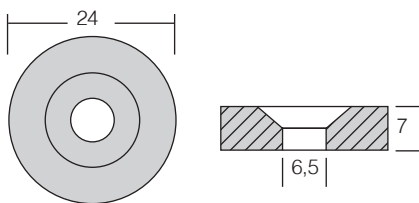

- type **Honda** -

cod. **OBHMT-802522**

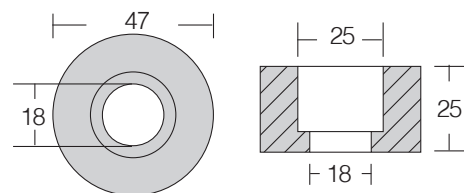

- type **Hamilton** -



# ENGINE COOLING SYSTEM ANODES

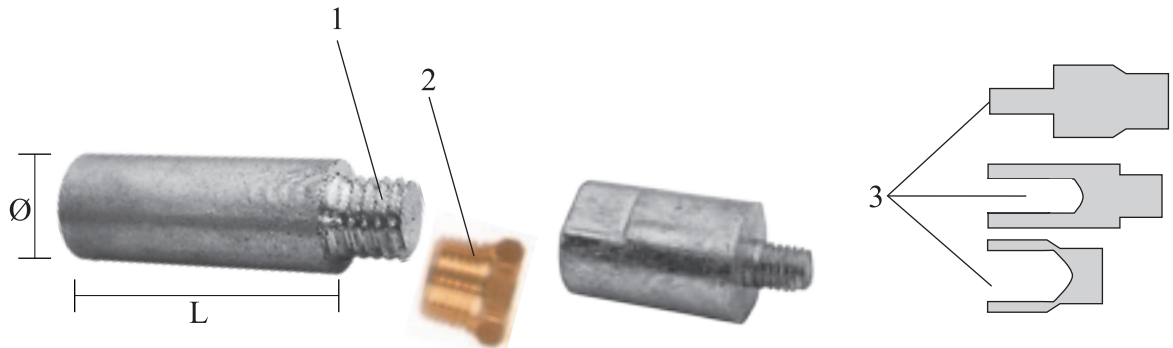

| engine         | CODE           | details      | Ø     | L  | 1         | 2         | 3        |
|----------------|----------------|--------------|-------|----|-----------|-----------|----------|
| Volvo Penta    | OBVP-800713    | anode        | 15,5  | 40 | 7/16 unc  |           |          |
|                | OBVP-800713/p  | plug         |       |    |           | 1/2" gas  |          |
|                | OBVP-800714    | anode        | 16    | 30 | 7/16 unc  |           | M8       |
|                | OBVP-800714/fp | female plug  |       |    |           | 1/2" gas  | 7/16 unc |
|                | OBVP-800714/mp | male plug    |       |    |           | 1/2" gas  | M8       |
|                | OBVP-800715    | anode        | 16,5  | 13 | 5/16" unc |           |          |
|                | OBVP-800716    | anode        | 25    | 44 | 3/8" unc  |           |          |
|                | OBVP-800716/p  | plug         |       |    |           | 1" gas    |          |
| BMW            | OBBMW-801010   | anode        | 13    | 50 | 3/8" unc  |           |          |
| Yamaha         | OBYMH-801114   | anode        | 20    | 39 | M8        |           |          |
| Yanmar         | OBYM-801300    | anode        | 21    | 40 | M8        |           |          |
|                | OBYM-801301    | anode        | 20    | 30 | M8        |           |          |
|                | OBYM-801303    | anode        | 20    | 20 | M8        |           |          |
|                | OBYM-801306    | anode        | 20    | 55 | M8        |           |          |
|                | OBYM-801309    | anode        | 23    | 40 | M8        |           |          |
|                | OBYM-801310    | anode        | 40    | 40 | M10       |           |          |
|                | OBYM-801311    | anode        | 30    | 40 | M8        |           |          |
|                | OBYM-801312    | anode        | 20    | 37 | M8        |           |          |
|                | OBYM-801313    | anode        | 20    | 30 | M8        |           |          |
|                | OBYM-801316    | anode        | 12,5  | 32 | 3/8" unc  |           |          |
|                | OBYM-801317    | anode        | 16    | 50 | 7/16" unc |           |          |
|                | OBYM-801317/p  | plug         |       |    |           | 1/2" gas  |          |
|                | OBYM-801318    | anode        | 12,5  | 30 | 3/8" unc  |           |          |
|                | OBYM-801318/p  | plug         |       |    |           | 3/8" gas  |          |
|                | General Motors | OBGGM-802000 | anode | 16 | 54        | 7/16" unc |          |
| OBGGM-802000/p |                | plug         |       |    |           | 1/2" gas  |          |
| OBGGM-802001   |                | anode        | 19    | 85 | 5/8" unc  |           |          |
| OBGGM-802001/p |                | plug         |       |    |           | 3/4" gas  |          |
| OBGGM-802002   |                | anode        | 19    | 54 | 5/8" unc  |           |          |
| OBGGM-802002/p |                | plug         |       |    |           | 3/4" gas  |          |
| OBGGM-802003   |                | anode        | 12    | 40 | 3/8" unc  |           |          |
| OBGGM-802003/p |                | plug         |       |    |           | 3/8" gas  |          |

# ENGINE COOLING SYSTEM ANODES

| engine            | CODE              | details | Ø    | L        | 1         | 2         | 3 |
|-------------------|-------------------|---------|------|----------|-----------|-----------|---|
| AIFO              | OBAF-8020I0       | anode   | 14   | 26       | Ø12x8     |           |   |
|                   | OBAF-8020I0/p     | plug    |      |          |           | M18x1,5   |   |
|                   | OBAF-8020I0/2     | anode   | 13   | 26       | Ø10x7     |           |   |
|                   | OBAF-8020 1 0/2 P | plug    |      |          |           | M18x1,5   |   |
|                   | OBAF-8020II       | anode   | 20   | 20       | Ø14x11    |           |   |
|                   | OBAF -8020 II/p   | plug    |      |          |           | M28x1,5   |   |
|                   | OBAF-8020I2       | anode   | 13   | 26       | Ø10x8     |           |   |
|                   | OBAF-8020I2/p     | plug    |      |          |           | M16x1,5   |   |
|                   | OBAF-8020I3       | anode   | 10   | 18       | Ø7x8      |           |   |
|                   | OBAF -8020 I3/p   | plug    |      |          |           | M12x1,5   |   |
|                   | OBAF-8020I4/p     | plug    |      |          |           | M10x1     |   |
|                   | OBAF -8020 I5/p   | plug    |      |          |           | M10x1,25  |   |
|                   | OBAF-8020I7       | anode   | 14   | 40       | M8        |           |   |
|                   | OBAF -802017 /p   | plug    |      |          |           | M18x1,5   |   |
| Caterpillar       | OBCTP-802020      | anode   | 14   | 26       | Ø10x7     |           |   |
|                   | OBCTP-80202I      | anode   | 10   | 55       | 1/4" unc  |           |   |
|                   | OBCTP-80202I/p    | plug    |      |          |           | 1/4" gas  |   |
|                   | OBCTP-80202I/2    | anode   | 9    | 35       | 1/4" unc  |           |   |
|                   | OBCTP-80202I/2 p  | plug    |      |          |           | 7/16" unf |   |
|                   | OBCTP-802022      | anode   | 22   | 20       | 5/8" unf  |           |   |
|                   | OBCTP-802022/p    | plug    |      |          |           | 3/4" gas  |   |
|                   | OBCTP-802023      | anode   | 16   | 76       | 3/8" unc  |           |   |
|                   | OBCTP-802023/p    | plug    |      |          |           | 1/2" gas  |   |
|                   | OBCTP-802024      | anode   | 16   | 63       | 3/8" unc  |           |   |
|                   | OBCTP-802024/p    | plug    |      |          |           | 1/2" gas  |   |
|                   | OBCTP-802025      | anode   | 14   | 33       | 5/16" unc |           |   |
|                   | OBCTP-802026      | anode   | 28   | 55       | 3/4" unc  |           |   |
|                   | OBCTP-802026/p    | plug    |      |          |           | 1" 1/4gas |   |
|                   | OBCTP-802027      | anode   | 12   | 40       | 3/8" unc  |           |   |
|                   | OBCTP-802027/p    | plug    |      |          |           | 3/8" gas  |   |
|                   | OBCTP-802028      | anode   | 16   | 41       | 7/16 unf  |           |   |
|                   | OBCTP-802028/p    | plug    |      |          |           | 1/2" gas  |   |
|                   | OBCTP-802029      | anode   | 12,5 | 38       | 7/16" unf |           |   |
|                   | OBCTP-802029/p    | plug    |      |          |           | 3/8" gas  |   |
| OBCTP-802029/2    | anode             | 10      | 38   | 1/4" unc |           |           |   |
| OBCTP-802029/ 2 p | plug              |         |      |          | 1/4" gas  |           |   |
| Onan              | OBON-802030       | anode   | 10   | 30       | Ø8x6      |           |   |
|                   | OBON-80203I       | anode   | 13   | 26       | Ø9,5x5    |           |   |
|                   | OBON-802032       | anode   | 10   | 31       | M8        |           |   |
|                   | OBON-802033       | anode   | 12   | 40       | 3/8" unc  |           |   |
| Castoldi          | OBCST-802402      | anoda   | 22   | 26       | M10       |           |   |

# ENGINE COOLING SYSTEM ANODES

| engine            | CODE            | details | Ø    | L    | 1         | 2        | 3  |
|-------------------|-----------------|---------|------|------|-----------|----------|----|
| Cummins           | OBCMM-802040    | anode   | 18   | 65   | M16x1,5   |          |    |
|                   | OBCMM-802041    | anode   | 16   | 31   | 3/8" unc  |          |    |
|                   | OBCMM-802042    | anode   | 10   | 20   | M6        |          |    |
|                   | OBCMM-802043    | anode   | 16   | 50   | Ø15,5x10  |          |    |
|                   | OBCMM-802043/p  | plug    |      |      |           | 1/2" gas |    |
|                   | OBCMM-802044    | anode   | 16   | 50   | 7/16" unf |          |    |
|                   | OBCMM-802044/p  | plug    |      |      |           | 1/2" gas |    |
| Bukh              | OBBK-802050     | anode   | 12   | 35   | M5        |          |    |
|                   | OBBK-802050/p   | plug    |      |      |           | 3/8" gas |    |
|                   | OBBK-802052     | anode   | 12   | 40   | 3/8" unc  |          |    |
|                   | OBBK-802053     | anode   | 10   | 18   | Ø8,5x8    |          |    |
|                   | OBBK-802053/p   | plug    |      |      |           | 1/4" gas |    |
| VM                | OBVM-802060     | anode   | 14   | 40   | M8        |          |    |
|                   | OBVM-802060/p   | plug    |      |      |           | M18x1,5  |    |
|                   | OBVM-802061     | anode   | 14   | 20   | M8        |          |    |
|                   | OBVM-802061/p   | plug    |      |      |           | M18x1,5  |    |
|                   | OBVM-802064     | anode   | 14,5 | 20   | M10       |          | M8 |
| Ford              | OBFR-802070     | anode   | 10   | 18   | Ø8,5x8    |          |    |
|                   | OBFR-802070/p   | plug    |      |      |           | 1/4" gas |    |
|                   | OBFR-80207012   | anode   | 10   | 30   |           |          |    |
|                   | OBFR-802071     | anode   | 14   | 26   | Ø12x7     |          |    |
|                   | OBFR-802071/p   | plug    |      |      |           | 1/2" gas |    |
| Isotta F.         | OBIF-802080     | anode   | 20   | 33,5 | M18x1,5   |          |    |
| Renault           | OBRN-802090     | anode   | 15   | 22   | Ø12x10    |          |    |
|                   | OBRN-802090/p   | plug    |      |      |           | M18x1,5  |    |
| Nanni<br>Mercedes | OBNM-802100     | anode   | 10   | 17   | Ø8x9      |          |    |
|                   | OBNM-802100/p   | plug    |      |      |           | M16x1,5  |    |
|                   | OBNM-802101     | anode   | 14   | 26   | Ø10x8     |          |    |
|                   | OBNM-802102     | anode   | 26   | 25   | Ø22x10    |          |    |
| Mitsubishi        | OBMTH-802111    | anode   | 34   | 30   | M8        |          |    |
| Scania            | OBSCN-802200    | anode   | 17   | 45   | M12x1     |          |    |
|                   | OBSCN -802200/p | plug    |      |      |           | 1/2" gas |    |
|                   | OBSCN-802201    | anode   | 17   | 45   | M6        |          |    |
|                   | OBSCN-802201/p  | plug    |      |      |           | 1/2" gas |    |
| Baudouin          | OBBD-802300     | anode   | 20   | 45   | 8x1,25    |          |    |
|                   | OBBD-802300/p   | plug    |      |      |           | M24x1,5  |    |
| Lombardini        | OBLMD-802350    | anode   | 14   | 26   | Ø12x7     |          |    |
|                   | OBLMD-802350/p  | plug    |      |      |           | 1/2" gas |    |
|                   | OBLMD-802351    | anode   | 10   | 18   | Ø8,5x8    |          |    |
|                   | OBLMD-802351/p  | plug    |      |      |           | 1/4" gas |    |
|                   | OBLMD-802353    | anode   | 15   | 30   | Ø10x8     |          |    |
|                   | OBLMD-802353/p  | plug    |      |      |           | M16x1,5  |    |
| Ruggerini         | OBRGG-802380    | anode   | 20   | 23   |           |          |    |

# SHAFTS ANODES

| cod.         | Ø axis      | kg    | Ø  | Ø1   | h  | holes |
|--------------|-------------|-------|----|------|----|-------|
| OBSHF-800500 | 19.0 3/4"   | 0.530 | 58 | 19.0 | 56 | 2     |
| OBSHF-800501 | 22.0 7/8"   | 0.513 | 58 | 22.0 | 56 | 2     |
| OBSHF-800502 | 25.0        | 0.502 | 58 | 25.0 | 56 | 2     |
| OBSHF-800503 | 25.4 1"     | 0.500 | 58 | 25.4 | 56 | 2     |
| OBSHF-800504 | 28.0        | 0.463 | 58 | 28.0 | 56 | 2     |
| OBSHF-800505 | 28.6 1 1/8" | 0.456 | 58 | 28.6 | 56 | 2     |
| OBSHF-800506 | 30.0        | 0.450 | 58 | 30.0 | 56 | 2     |
| OBSHF-800507 | 31.5 1 1/4" | 0.430 | 58 | 31.8 | 56 | 2     |
| OBSHF-800508 | 34.0        | 0.590 | 65 | 34.0 | 66 | 4     |
| OBSHF-800509 | 35.0 1 3/8" | 0.585 | 65 | 35.0 | 66 | 4     |
| OBSHF-800510 | 38.0 1 1/2" | 0.550 | 65 | 38.0 | 66 | 4     |
| OBSHF-800511 | 40.0        | 1.050 | 81 | 40.0 | 77 | 4     |

| cod.          | Ø axis      | kg    | Ø   | Ø1   | h   | holes |
|---------------|-------------|-------|-----|------|-----|-------|
| OBSHF-800511M | 44.4 1 3/4" | 0.934 | 81  | 44.4 | 77  | 4     |
| OBSHF-800512  | 45.0        | 0.885 | 81  | 45.0 | 77  | 4     |
| OBSHF-800513  | 50.0        | 1.210 | 93  | 50.0 | 88  | 4     |
| OBSHF-800514  | 50.8 2"     | 1.200 | 93  | 50.8 | 88  | 4     |
| OBSHF-800515  | 55.0        | 1.088 | 93  | 55.0 | 88  | 4     |
| OBSHF-800516  | 57.1 2 1/4" | 1.050 | 93  | 57.1 | 88  | 4     |
| OBSHF-800517  | 60.0        | 1.845 | 100 | 60.0 | 100 | 4     |
| OBSHF-800518  | 63.5 2 1/2" | 1.718 | 100 | 63.5 | 100 | 4     |
| OBSHF-800519  | 65.0        | 1.700 | 100 | 65.0 | 100 | 4     |
| OBSHF-800520  | 70.0        | 2.650 | 128 | 70.0 | 107 | 4     |
| OBSHF-800521M | 76.2 3"     | 2.580 | 128 | 76.2 | 107 | 4     |

**\*Available on special request:**

| cod.         | Ø axis | Ø   | Ø1   | h   | holes |
|--------------|--------|-----|------|-----|-------|
| OBSHF-800521 | 75.0   | 128 | 75.0 | 107 | 4     |
| OBSHF-800522 | 80.0   | 128 | 80.0 | 107 | 4     |
| OBSHF-800523 | 85.0   | 128 | 85.0 | 107 | 4     |

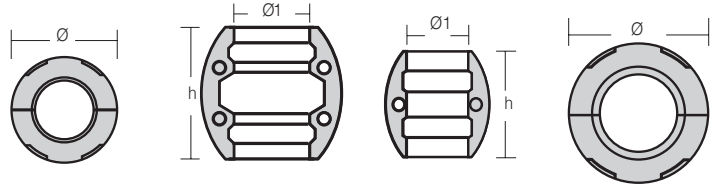

| cod.         | Ø axis      | kg    | Ø   | Ø1   | h   | holes |
|--------------|-------------|-------|-----|------|-----|-------|
| OBSHF-800524 | 90.0 3 1/2" | 4.600 | 132 | 90.0 | 112 | 4     |

**\*Available on special request:**

| cod.         | Ø axis | Ø   | Ø1    | h   | holes |
|--------------|--------|-----|-------|-----|-------|
| OBSHF-800525 | 95.0   | 142 | 95.0  | 114 | 4     |
| OBSHF-800526 | 100.0  | 142 | 100.0 | 114 | 4     |

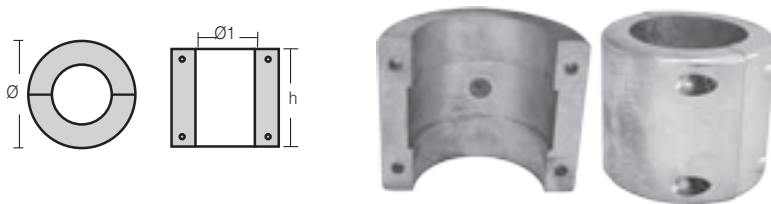

| cod.         | Ø axis | Ø    | kg   |
|--------------|--------|------|------|
| OBSHF-800530 | 19mm   | 44mm | 0.20 |
| OBSHF-800531 | 22mm   | 44mm | 0.18 |
| OBSHF-800532 | 25mm   | 44mm | 0.16 |
| OBSHF-800533 | 30mm   | 49mm | 0.20 |



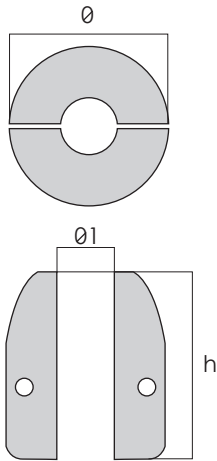

|              | Ø axis   | kg    | Ø   | Ø1       | h   | holes |
|--------------|----------|-------|-----|----------|-----|-------|
| OBSHF-800534 | 19       | 0.690 | 55  | 19       | 65  | 2     |
| OBSHF-800535 | 22       | 0.657 | 55  | 22       | 65  | 2     |
| OBSHF-800536 | 25       | 0.610 | 55  | 25       | 65  | 2     |
| OBSHF-800537 | 30       | 0.530 | 55  | 30       | 65  | 2     |
| OBSHF-800538 | 32 1"1/4 | 1.239 | 70  | 32 1"1/4 | 77  | 2     |
| OBSHF-800539 | 35       | 1.230 | 70  | 35       | 77  | 2     |
| OBSHF-800540 | 38 1"1/2 | 1.079 | 70  | 38 1"1/2 | 77  | 2     |
| OBSHF-800541 | 40       | 1.070 | 70  | 40       | 77  | 2     |
| OBSHF-800542 | 45       | 2.400 | 85  | 45       | 101 | 2     |
| OBSHF-800543 | 50       | 2.100 | 85  | 50       | 101 | 2     |
| OBSHF-800544 | 60       | 1.530 | 85  | 60       | 101 | 2     |
| OBSHF-800545 | 65       | 2.640 | 110 | 65       | 101 | 4     |
| OBSHF-800546 | 70       | 2.620 | 110 | 70       | 101 | 4     |

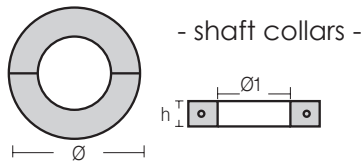

- shaft collars -



| cod.         | Ø axis     | kg    | Ø  | Ø1   | h  |
|--------------|------------|-------|----|------|----|
| OBSHF-800550 | 19.0 3/4"  | 0.320 | 65 | 19.0 | 18 |
| OBSHF-800551 | 22.0 7/8"  | 0.310 | 65 | 22.0 | 18 |
| OBSHF-800552 | 25.0       | 0.297 | 65 | 25.0 | 18 |
| OBSHF-800553 | 25.4 1"    | 0.294 | 65 | 25.4 | 18 |
| OBSHF-800554 | 28.6 1"1/8 | 0.280 | 65 | 28.6 | 18 |
| OBSHF-800555 | 30.0       | 0.271 | 65 | 30.0 | 18 |
| OBSHF-800556 | 31.8 1"1/4 | 0.260 | 65 | 31.8 | 18 |
| OBSHF-800557 | 35.0       | 0.243 | 65 | 35.0 | 18 |
| OBSHF-800558 | 40.0       | 0.448 | 80 | 40.0 | 20 |
| OBSHF-800559 | 45.0 1"3/4 | 0.410 | 80 | 45.0 | 20 |
| OBSHF-800560 | 50.0       | 0.690 | 90 | 50.0 | 25 |

\*Available on special request:

| cod.         | Ø axis     | Ø   | Ø1   | h  |
|--------------|------------|-----|------|----|
| OBSHF-800561 | 55.0       | 110 | 55.0 | 30 |
| OBSHF-800562 | 38.0       | 65  | 38.0 | 20 |
| OBSHF-800563 | 57.1 2"1/4 | 110 | 57.1 | 30 |
| OBSHF-800564 | 60.0       | 110 | 60.0 | 30 |
| OBSHF-800565 | 63.5       | 110 | 63.5 | 30 |
| OBSHF-800566 | 65.0       | 110 | 65.0 | 30 |
| OBSHF-800567 | 70.0       | 120 | 70.0 | 30 |
| OBSHF-800568 | 75.0       | 120 | 75   | 30 |
| OBSHF-800569 | 80.0       | 135 | 80   | 32 |
| OBSHF-800570 | 85.0       | 135 | 85   | 32 |
| OBSHF-800571 | 90.0       | 135 | 90   | 32 |
| OBSHF-800572 | 95.0       | 135 | 95   | 32 |
| OBSHF-800573 | 100.0      | 148 | 100  | 32 |
| OBSHF-800575 | 110.0      | 204 | 110  | 40 |
| OBSHF-800576 | 115.0      | 204 | 115  | 40 |
| OBSHF-800577 | 120        | 204 | 120  | 40 |

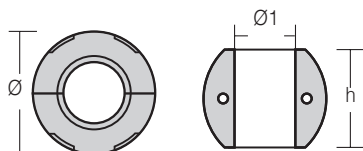

\*Available on special request:

| cod.           | Ø axis    | Ø  | Ø1   | h  |
|----------------|-----------|----|------|----|
| OBSHF-800500/1 | 19.0 3/4" | 50 | 19.0 | 40 |
| OBSHF-800501/1 | 22.0 7/8" | 50 | 22.0 | 40 |
| OBSHF-800502/1 | 25.0      | 50 | 25.0 | 40 |
| OBSHF-800503/1 | 25.4 1"   | 50 | 25.4 | 40 |
| OBSHF-800504/1 | 28.0      | 50 | 28.0 | 40 |

# ANODES FOR PROPELLERS

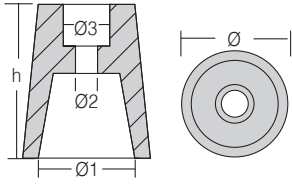

- type **conic ogive** -

**\*Available on special request:**

| cod.         | Ø axis | Ø  | Ø1 | Ø2   | Ø3   | h  | kg    |
|--------------|--------|----|----|------|------|----|-------|
| OBPRP-800400 | 22-25  | 33 | 25 | 6.5  | 11.0 | 39 | 0.113 |
| OBPRP-800401 | 30     | 42 | 32 | 8.5  | 13.5 | 53 | 0.250 |
| OBPRP-800402 | 35     | 46 | 38 | 8.5  | 13.5 | 61 | 0.392 |
| OBPRP-800403 | 40     | 51 | 42 | 8.5  | 14.0 | 68 | 0.530 |
| OBPRP-800404 | 45     | 61 | 48 | 11.0 | 24.0 | 76 | 0.835 |
| OBPRP-800405 | 50     | 73 | 57 | 11.0 | 27.0 | 84 | 1.125 |
| OBPRP-800406 | 55     | 75 | 65 | 11.0 | 28.0 | 87 | 1.155 |

| cod.          | Ø axis | Ø   | Ø1   | Ø2   | Ø3   | h   |
|---------------|--------|-----|------|------|------|-----|
| OBPRP-800407  | 60     | 82  | 71   | 11.0 | 24.0 | 98  |
| OBPRP-800409  | 100    | 98  | 84.5 | 11.0 | 17.0 | 98  |
| OBPRP-800409A | 110    | 160 | 130  | 15.0 | 24.0 | 134 |

**\*Complete with brass available on special request:**

| cod.         | Ø axis | Ø   | Ø1     | h  | h1 | c  |
|--------------|--------|-----|--------|----|----|----|
| OBPRP-800410 | 22-25  | 37  | 16x1.5 | 20 | 18 | 30 |
| OBPRP-800411 | 30     | 45  | 20x1.5 | 22 | 21 | 32 |
| OBPRP-800412 | 35     | 50  | 24x2.0 | 24 | 24 | 36 |
| OBPRP-800413 | 40     | 55  | 24x2.0 | 27 | 27 | 41 |
| OBPRP-800414 | 45     | 65  | 33x2.0 | 30 | 30 | 50 |
| OBPRP-800415 | 50     | 75  | 36x3.0 | 39 | 33 | 54 |
| OBPRP-800416 | 55     | 80  | 40x3.0 | 40 | 40 | 63 |
| OBPRP-800417 | 60     | 90  | 45x3.0 | 41 | 44 | 63 |
| OBPRP-800419 | 100    | 100 | 50x3.0 | 46 | 54 | 75 |

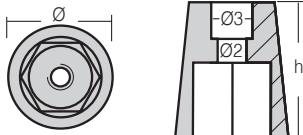
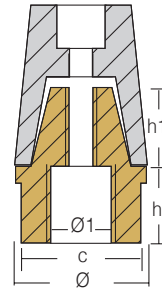

- type **hexagonal ogive** -



| cod.          | Ø axis | Ø  | Ø2 | Ø3 | h  | kg    |
|---------------|--------|----|----|----|----|-------|
| OBPRP-800400E | 22-25  | 34 | 7  | 11 | 39 | 0.123 |
| OBPRP-800401E | 30     | 43 | 9  | 17 | 53 | 0.263 |
| OBPRP-800402E | 35     | 46 | 9  | 18 | 62 | 0.350 |
| OBPRP-800403E | 40     | 52 | 9  | 18 | 67 | 0.472 |
| OBPRP-800404E | 45     | 61 | 11 | 24 | 76 | 0.805 |

| cod.                                  | Ø axis | Ø  | Ø2 | Ø3 | h  | kg    |
|---------------------------------------|--------|----|----|----|----|-------|
| OBPRP-800405E                         | 50     | 73 | 11 | 24 | 84 | 1.020 |
| OBPRP-800406E                         | 55     | 75 | 11 | 22 | 87 | 1.035 |
| OBPRP-800407E                         | 60     | 82 | 11 | 23 | 98 | 1.650 |
| <b>*Available on special request:</b> |        |    |    |    |    |       |
| OBPRP-800409E                         | 100    | 98 | 11 | 22 | 97 |       |

**\*Complete with brass available on special request:**

| cod.          | Ø axis | Ø   | Ø1     | h  | h1 | c  |
|---------------|--------|-----|--------|----|----|----|
| OBPRP-800410E | 22-25  | 37  | 16x1.5 | 18 | 18 | 22 |
| OBPRP-800411E | 30     | 45  | 20x1.5 | 22 | 21 | 32 |
| OBPRP-800412E | 35     | 50  | 24x2.0 | 24 | 24 | 36 |
| OBPRP-800413E | 40     | 55  | 24x2.0 | 27 | 26 | 41 |
| OBPRP-800414E | 45     | 65  | 33x2.0 | 29 | 29 | 50 |
| OBPRP-800415E | 50     | 75  | 36x3.0 | 29 | 44 | 55 |
| OBPRP-800416E | 55     | 80  | 40x3.0 | 35 | 40 | 60 |
| OBPRP-800417E | 60     | 90  | 45x3.0 | 41 | 44 | 65 |
| OBPRP-800419E | 100    | 100 | 50x3.0 | 46 | 54 | 75 |

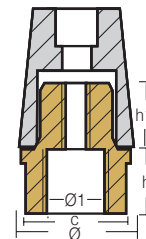



# ANODES FOR PROPELLERS

cod. **OBPRP-800405Q**

0.995 kg

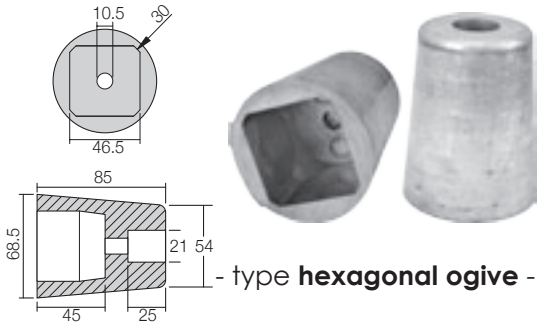

cod. **OBPRP-800432MT**

| Ø axis | kg    | Ø  | Ø1 | h  |
|--------|-------|----|----|----|
| 50-100 | 0.781 | 66 | 46 | 73 |

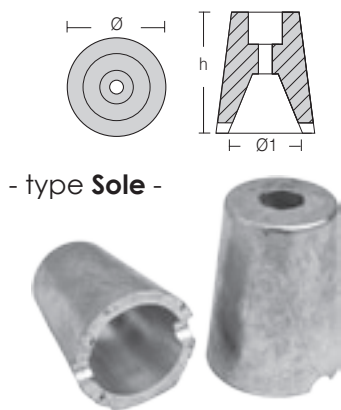
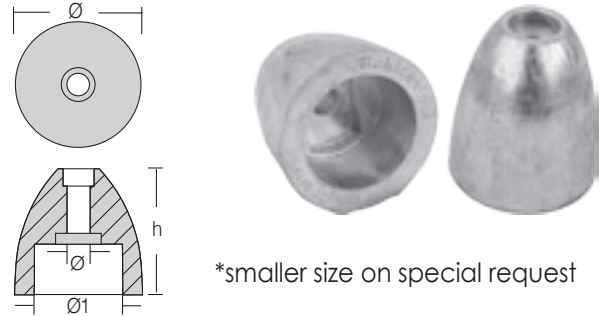

cod. **OBPRP-800400SOLE/3**

| Ø  | Ø1 | h  | kg    |
|----|----|----|-------|
| 47 | 36 | 60 | 0.350 |

cod. **OBPRP-800400SOLE/4**

|    |    |    |       |
|----|----|----|-------|
| 55 | 45 | 70 | 0.450 |
|----|----|----|-------|

**\*Available on special request:**

cod. **OBPRP-800400SOLE/1**

|    |    |    |  |
|----|----|----|--|
| 32 | 24 | 39 |  |
|----|----|----|--|

cod. **OBPRP-800400SOLE/2**

|    |    |    |  |
|----|----|----|--|
| 37 | 26 | 46 |  |
|----|----|----|--|

| cod. <b>OBPRP-800467</b> | Øaxis | Ø  | Ø1 | Ø2   | h  | kg    |
|--------------------------|-------|----|----|------|----|-------|
|                          | 60    | 88 | 55 | 11.0 | 85 | 2.150 |



| cod. <b>OBPRP-800483</b> | Ø   | Ø1 | h  | kg    |
|--------------------------|-----|----|----|-------|
|                          | 100 | 52 | 61 | 0.890 |

|                          |     |    |    |       |
|--------------------------|-----|----|----|-------|
| cod. <b>OBPRP-800486</b> | 120 | 81 | 78 | 1.400 |
|--------------------------|-----|----|----|-------|

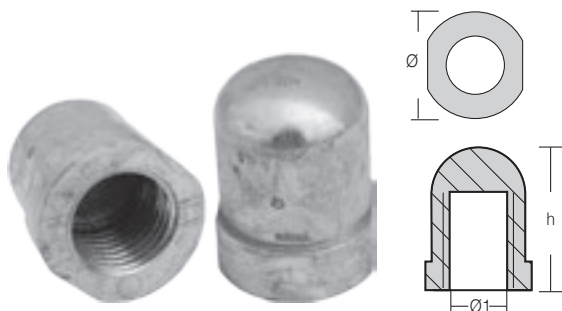
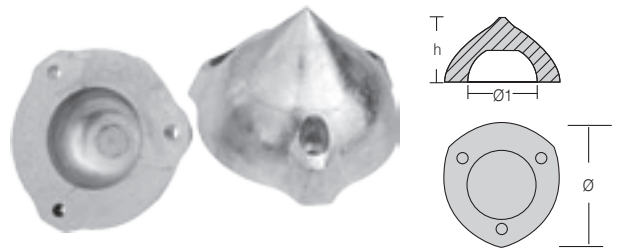

| cod.                | Ø  | Ø1   | h  | kg    |
|---------------------|----|------|----|-------|
| <b>OBPRP-800490</b> | 35 | M20  | 52 | 0.157 |
| <b>OBPRP-800491</b> | 40 | M24  | 50 | 0.203 |
| <b>OBPRP-800492</b> | 40 | M27  | 50 | 0.230 |
| <b>OBPRP-800493</b> | 40 | M30  | 50 | 0.214 |
| <b>OBPRP-800494</b> | 35 | 20x2 | 52 | 0.153 |
| <b>OBPRP-800495</b> | 40 | 26x2 | 50 | 0.236 |



Available on special request:

|                          | $\emptyset$ | $\emptyset 1$ | h  |
|--------------------------|-------------|---------------|----|
| cod. <b>OBPRP-800435</b> | 116         | 88.1          | 86 |
| cod. <b>OBPRP-800436</b> | 155         | 116           | 95 |

- type **RIVA** -

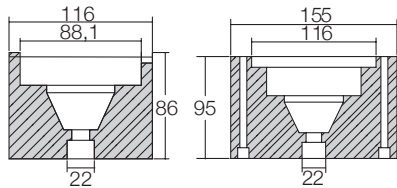

|                          | $\emptyset$ | $\emptyset 1$ | h   |
|--------------------------|-------------|---------------|-----|
| cod. <b>OBPRP-800479</b> | 155         | 116           | 122 |

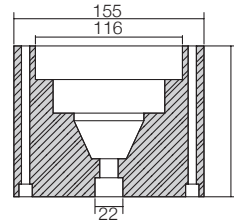

- type **Ferreti** -

|                          | $\emptyset$ | $\emptyset 1$ | $\emptyset 2$ | h  | i   |
|--------------------------|-------------|---------------|---------------|----|-----|
| cod. <b>OBPRP-809000</b> | 140         | 14            | 8             | 25 | 110 |
| cod. <b>OBPRP-809001</b> | 135         | 14            | 8             | 20 | 115 |
| cod. <b>OBPRP-809002</b> | 125         | 13.5          | 8             | 25 | 105 |

- type **Turian** -

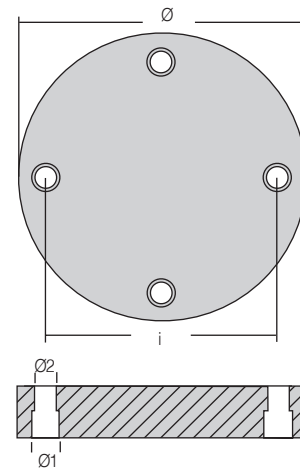

cod. **OBPRP-809003**  $\emptyset$  240

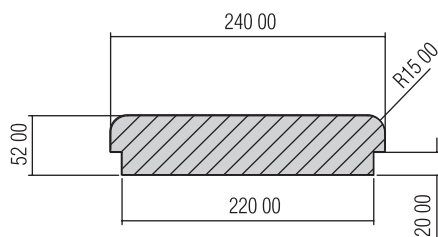

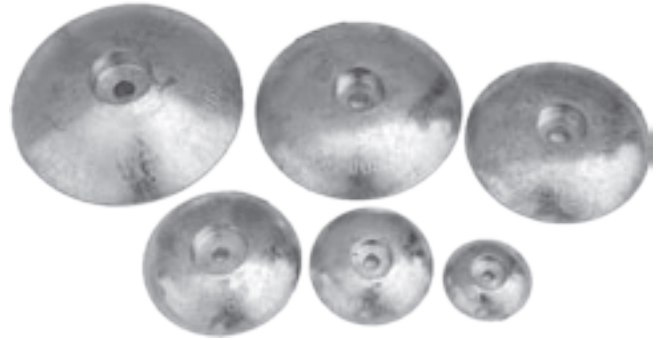
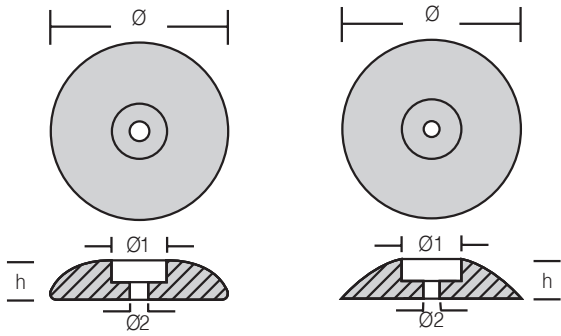

| code          | Ø   | Ø 1 | Ø 2 | h  | kg    |
|---------------|-----|-----|-----|----|-------|
| OBRDR-800100  | 50  | 20  | 6,5 | 11 | 0,083 |
| OBRDR-800101  | 70  | 22  | 8,5 | 13 | 0,203 |
| OBRDR-800102  | 90  | 31  | 8,5 | 18 | 0,450 |
| OBRDR-800103  | 110 | 30  | 11  | 18 | 0,700 |
| OBRDR-800104  | 125 | 30  | 11  | 21 | 1,010 |
| OBRDR-800105  | 140 | 35  | 12  | 30 | 1,500 |
| OBRDR-800105P | 140 | 31  | 12  | 33 | 2,050 |
| OBRDR-800106  | 190 | 35  | 13  | 27 | 3,820 |

## Available on special request:

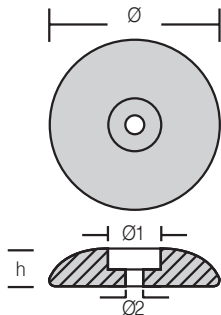

| code          | Ø   | Ø 1 | Ø 2 | h  |
|---------------|-----|-----|-----|----|
| OBRDR-800100P | 50  | 21  | 7   | 15 |
| OBRDR-800101P | 70  | 22  | 8,5 | 16 |
| OBRDR-800102P | 90  | 27  | 9   | 20 |
| OBRDR-800103P | 110 | 30  | 12  | 21 |
| OBRDR-800104P | 125 | 30  | 11  | 26 |

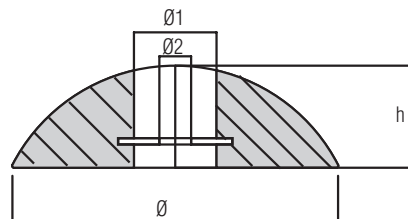

| code         | Ø   | Ø 1 | Ø 2 | h  |
|--------------|-----|-----|-----|----|
| OBRDR-800107 | 70  | 22  | 8,5 | 13 |
| OBRDR-800108 | 100 | 31  | 8,5 | 18 |
| OBRDR-800109 | 140 | 30  | 11  | 18 |

# STERN ANODES

|                          | $\emptyset$ | $\emptyset 1$ | $\emptyset 2$ | h  | kg    |
|--------------------------|-------------|---------------|---------------|----|-------|
| cod. <b>OBSTN-800130</b> | 140         | 52            | 14.5          | 30 | 2.760 |

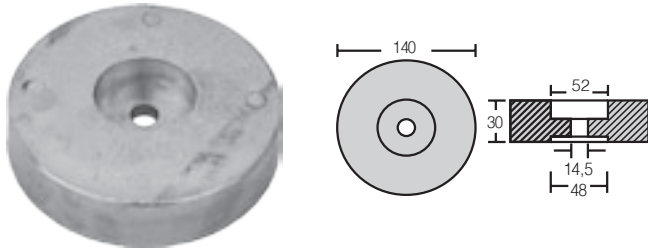

|                          | $\emptyset$ | $\emptyset 1$ | $\emptyset 2$ | h  | kg    |
|--------------------------|-------------|---------------|---------------|----|-------|
| cod. <b>OBSTN-800131</b> | 140         | 55            | 14.5          | 35 | 3.000 |

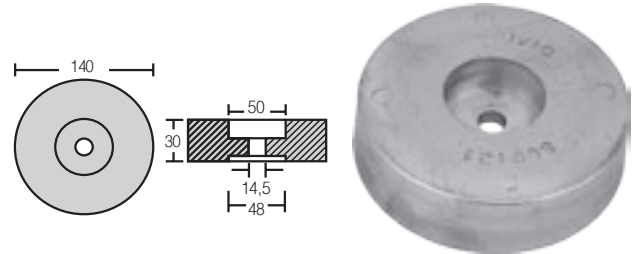

|                          | $\emptyset$ | $\emptyset 1$ | $\emptyset 2$ | h  | kg    |
|--------------------------|-------------|---------------|---------------|----|-------|
| cod. <b>OBSTN-800140</b> | 125         | 50            | 14.5          | 38 | 2.700 |

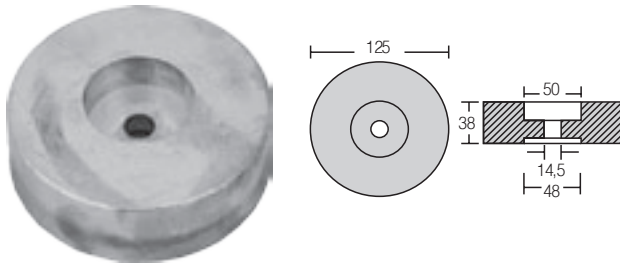

|                          | $\emptyset$ | $\emptyset 1$ | $\emptyset 2$ | h  | kg    |
|--------------------------|-------------|---------------|---------------|----|-------|
| cod. <b>OBSTN-800152</b> | 135         | 50x3          | 32            | 47 | 3.800 |

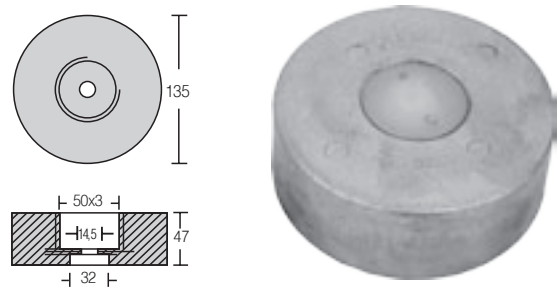

|                          | l   | a  | h  | $\emptyset 1$ | $\emptyset 2$ | kg    |
|--------------------------|-----|----|----|---------------|---------------|-------|
| cod. <b>OBSTN-800160</b> | 235 | 80 | 40 | 42x3          | 14.5          | 4.100 |

**\*complete with cap on special request**

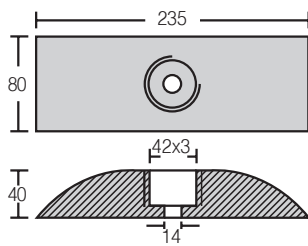

**Available on special request:**

|                          | $\emptyset$ | $\emptyset 1$ | $\emptyset 2$ | h  |
|--------------------------|-------------|---------------|---------------|----|
| cod. <b>OBSTN-800154</b> | 120         | 50x3          | 32            | 35 |

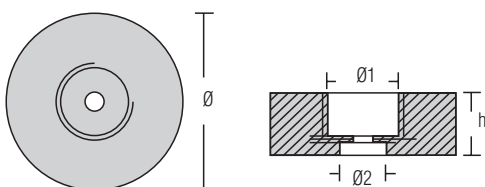

cod. **OBFLP-800201** l a h i Ø kg  
117 43 20 50 7 0.338

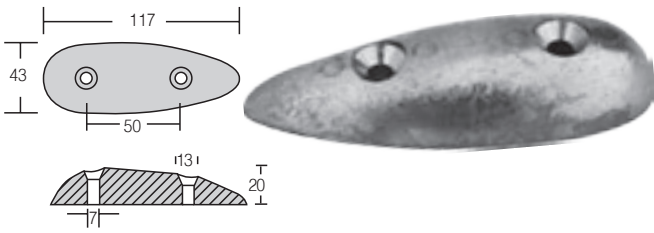

cod. **OBFLP-800202** l a h i Ø kg  
112 66 19 40 5.5 0.471

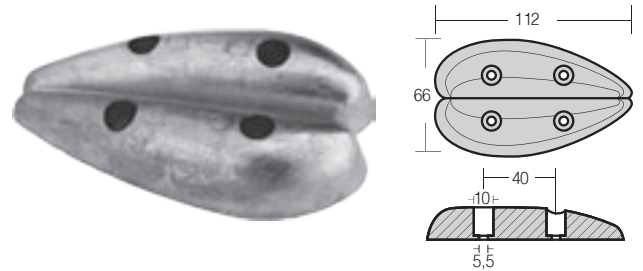

cod. **OBFLP-800203** l a h i Ø kg  
85 47 20 33 7 0.275

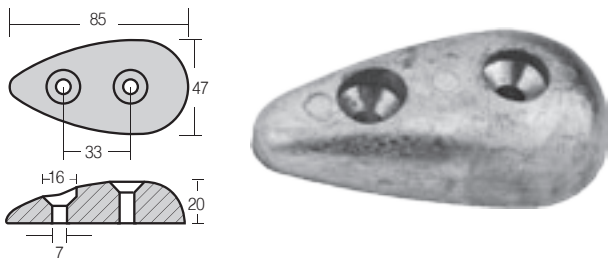

cod. **OBFLP-800204** l a h i Ø kg  
145 40 22 52 6.5 0.478

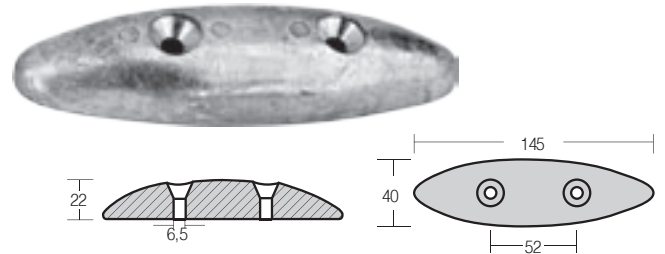

cod. **OBFLP-800205** l a h i Ø kg  
118 33 19 60 7 0.430

cod. **OBFLP-800206** l a h i Ø kg  
175 39 19 100 7 0.815

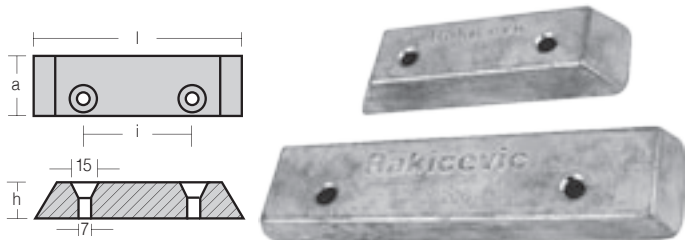

cod. **OBFLP-800211** l a h i Ø2 kg  
100 45 10 50 10 0.290



**\*Available on special request:**

cod. **OBFLP-800212** l a h i Ø2 kg  
110 67 20 57 7 0.663

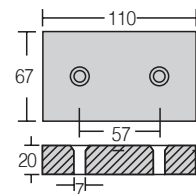

cod. **OBFLP-800213** l a h i Ø2 kg  
130 50 17 77 7 0.663

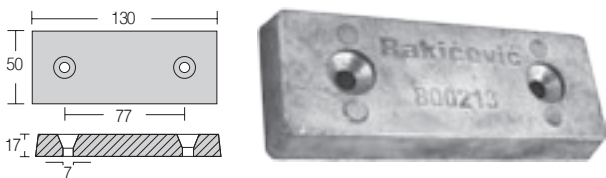

**\*Available on special request:**

cod. **OBFLP-800212/2** l a h i  
100 28 12 35

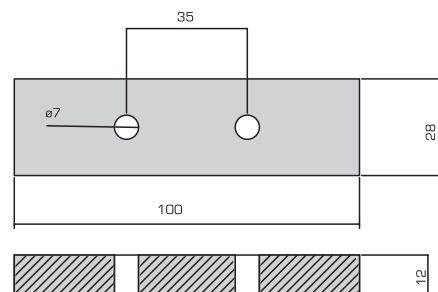

**\*Available on special request:**

cod. **OBFLP-800214** l a h i Ø2  
217 60 30 160 8

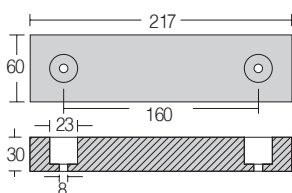

# BOLT-ON ANODES

l a h i Ø2 kg  
 cod. **OBLT-800217** 150 80 40 60 14 2.210

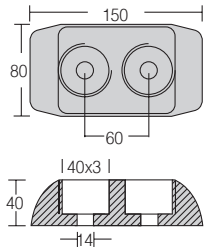

l a h i Ø2 kg  
 cod. **OBLT-800224** 105 65 30 40 11 0.970

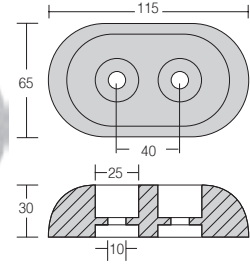

l a h i Ø1 Ø2 kg  
 cod. **OBLT-800220** 150 60 25 80 27 11x15 1.000

cod. **OBLT-800221** 240 65 29 140 32 13x25 2.286

cod. **OBLT-800222** 290 55 30 200 32 13x25 2.688

cod. **OBLT-800223** 350 72 35 200 38 13x25 4.850

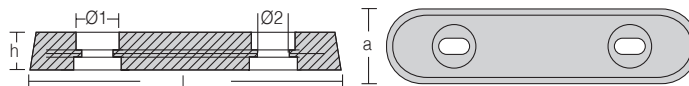

cod. **OBLT-800231** 4.00 kg

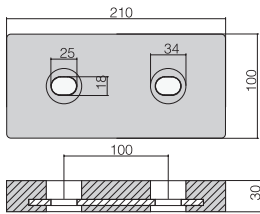

l a h i Ø kg  
 cod. **OBLT-800238** 210 100 30 110 19x25 4.2

\*other sizes on special request

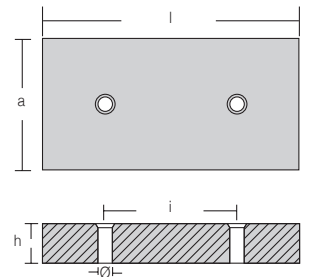

l a h i Ø kg  
 cod. **OBLT-800225** 325 80 30 180 13x25 4.700

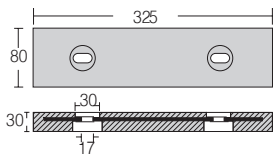

l a h kg  
 cod. **OBLT-800260** 190 50 25 1.500

\*Available on special request:

cod. **OBLT-800261** 190 65 30

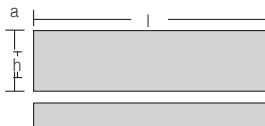

l a h i Ø kg  
 cod. **OBLT-800266** 200 110 30 130 13 3.500

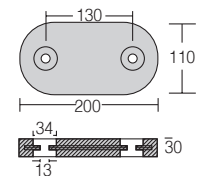

l a h i Ø kg  
 cod. **OBLT-800267** 151 69 25 75 13 1.500

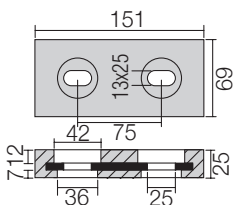

l a h i Ø kg  
 cod. **OBLT-800269E** 200 65 32 110 12 1.300

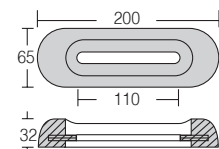

l a h i kg  
 cod. **OBBLT-800270E** 320 65 35 160 2.400

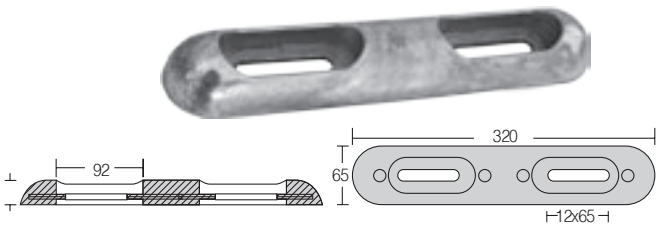

l a h i kg  
 cod. **OBBLT-800271E** 310 75 40 205 3.950

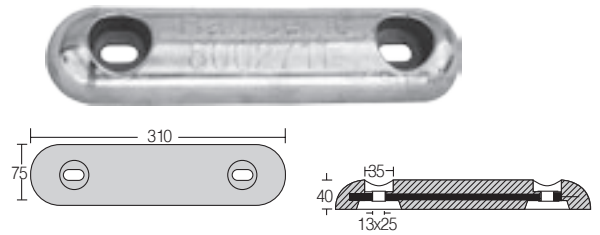

l a h i kg  
 cod. **OBBLT-800272E** 455 90 40 230 7.000

cod. **OBBLT-800273E** 460 100 45 230 10.200

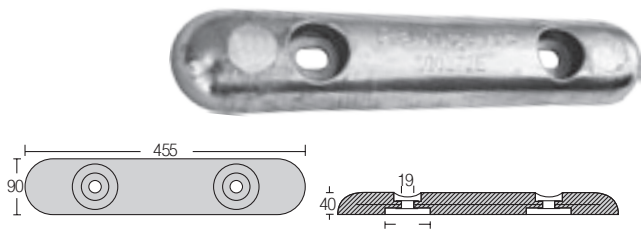

l a h i kg  
 cod. **OBBLT-800274E** 450 100 30 230 7.200

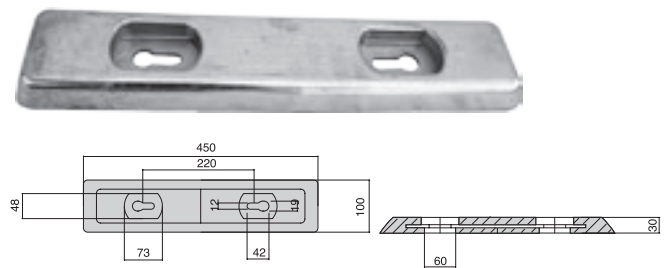

## Available on special request:

l a h holes Ø2  
 cod. **OBBLT-80021522** 81 20 5 5.5

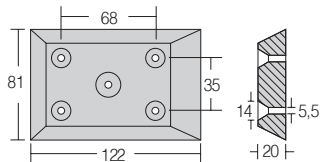

l a h holes Ø2  
 cod. **OBBLT-800216** 122 81 20 5 8.5

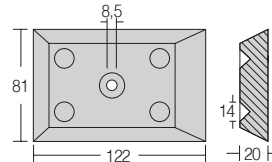

l a h i Ø2  
 cod. **OBBLT-8002193** 48 10 50 7

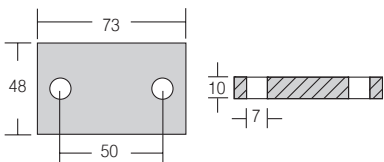

l a h i Ø  
 cod. **OBBLT-800229** 100 70 12 70 8

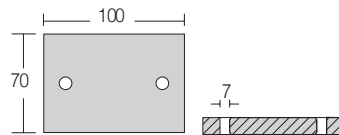

|              | l   | a   | h    |
|--------------|-----|-----|------|
| OBBLT-800250 | 300 | 150 | 10   |
| OBBLT-800251 | 300 | 150 | 16,5 |
| OBBLT-800252 | 300 | 150 | 22   |
| OBBLT-800253 | 300 | 150 | 27   |
| OBBLT-800254 | 300 | 200 | 20   |
| OBBLT-800255 | 300 | 150 | 26   |
| OBBLT-800256 | 300 | 150 | 33   |

|              | l   | a   | h  | Ø  |
|--------------|-----|-----|----|----|
| OBBLT-800262 | 200 | 100 | 20 | 10 |
| OBBLT-800263 | 130 | 80  | 30 | 10 |
| OBBLT-800264 | 300 | 150 | 28 | 10 |
| OBBLT-800265 | 200 | 70  | 30 | 10 |

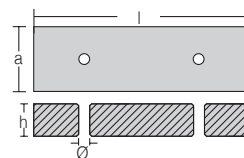
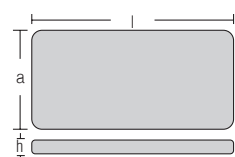

# WELD-ON ANODES

|              | l   | a  | h  | kg    |
|--------------|-----|----|----|-------|
| OBWLD-800300 | 115 | 60 | 17 | 0,680 |
| OBWLD-800301 | 110 | 63 | 26 | 1,070 |
| OBWLD-800302 | 200 | 70 | 25 | 1,840 |
| OBWLD-800303 | 215 | 70 | 29 | 2,270 |
| OBWLD-800304 | 200 | 90 | 35 | 3,000 |
| OBWLD-800305 | 250 | 90 | 36 | 4,000 |
| OBWLD-800306 | 300 | 80 | 40 | 5,000 |

\*Available on special request:

|              | l   | a   | h  |
|--------------|-----|-----|----|
| OBWLD-800307 | 295 | 90  | 40 |
| OBWLD-800308 | 300 | 125 | 40 |
| OBWLD-800309 | 320 | 147 | 40 |
| OBWLD-800310 | 400 | 152 | 33 |

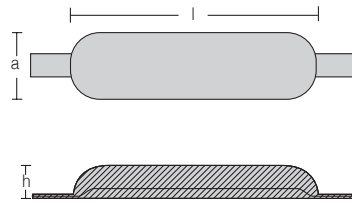
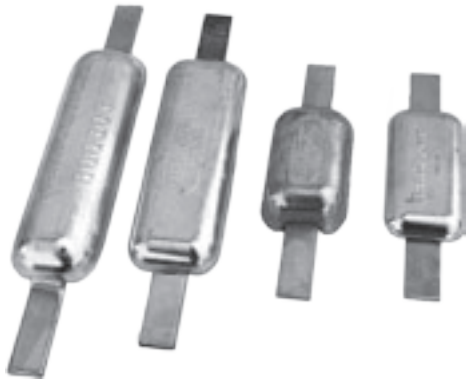

|                | l   | a   | h  | kg    |
|----------------|-----|-----|----|-------|
| OBWLD-800350   | 120 | 78  | 25 | 1,000 |
| OBWLD-800351   | 140 | 90  | 35 | 1,800 |
| OBWLD-800352   | 165 | 100 | 42 | 2,700 |
| OBWLD-800350B  | 120 | 78  | 25 | 1,000 |
| OBWLD-800352/A | 165 | 100 | 42 | 3,000 |

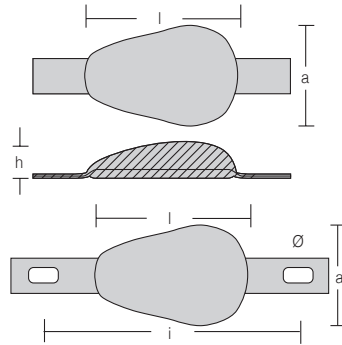

|              | kg    |
|--------------|-------|
| OBWLD-800360 | 4,450 |
| OBWLD-800361 | 5,900 |
| OBWLD-800362 | 7,000 |





|                                       | l   | a  | h  | ø     | b   | kg    |
|---------------------------------------|-----|----|----|-------|-----|-------|
| OBWLD-800385/1                        | 95  | 34 | 17 | 7x25  | 117 | 0,260 |
| OBWLD-800386                          | 95  | 40 | 25 | 9x20  | 129 | 0,500 |
| OBWLD-800387/1                        | 141 | 66 | 25 | 13x25 | 180 | 1,110 |
| <b>*Available on special request:</b> |     |    |    |       |     |       |
| OBWLD-800385                          | 75  | 34 | 16 | 9x20  | 133 | 0,250 |
| OBWLD-800387                          | 120 | 46 | 35 | 13x25 | 180 | 1,100 |
| OBWLD-800388                          | 140 | 82 | 26 | 13x25 | 180 | 1,900 |

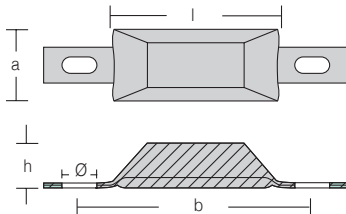

|              | kg     |
|--------------|--------|
| OBWLD-800390 | 0,250  |
| OBWLD-800391 | 0,500  |
| OBWLD-800392 | 1,000  |
| OBWLD-800393 | 2,000  |
| OBWLD-800394 | 3,500  |
| OBWLD-800395 | 5,500  |
| OBWLD-800396 | 10,550 |



## ROD ANODES



|             | Ø x l  |
|-------------|--------|
| OBRD-800600 | 10x400 |
| OBRD-800601 | 12x400 |
| OBRD-800602 | 14x400 |
| OBRD-800603 | 15x400 |
| OBRD-800604 | 16x400 |
| OBRD-800605 | 18x400 |
| OBRD-800606 | 20x400 |
| OBRD-800607 | 25x400 |
| OBRD-800608 | 30x400 |
| OBRD-800609 | 35x400 |
| OBRD-800610 | 40x400 |
| OBRD-800611 | 45x400 |
| OBRD-800612 | 45x500 |
| OBRD-800613 | 50x400 |

|             | Ø x l   |
|-------------|---------|
| OBRD-800614 | 50x500  |
| OBRD-800615 | 50x750  |
| OBRD-800616 | 55x400  |
| OBRD-800617 | 60x400  |
| OBRD-800618 | 65x400  |
| OBRD-800619 | 70x400  |
| OBRD-800620 | 75x400  |
| OBRD-800621 | 70x500  |
| OBRD-800622 | 80x400  |
| OBRD-800623 | 80x500  |
| OBRD-800624 | 100x400 |
| OBRD-800625 | 100x500 |
| OBRD-800626 | 85x400  |
| OBRD-800627 | 90x400  |

## MATERIAL COMPOSITION

| Type | Al    | Cu     | Fe    | Pb    | Cd     | Si    | Zn        |
|------|-------|--------|-------|-------|--------|-------|-----------|
| 231  | 0,396 | 0,0001 | 0,003 | 0,002 | 0,0542 | 0,001 | remaining |
| 232  | 0,395 | 0,0001 | 0,003 | 0,002 | 0,0541 | 0,001 | remaining |



## **Oblò srl**

### **Shop:**

Via dei Coralli n° 60  
33050 Aprilia Marittima - Ud - Italy  
Tel. +39 0431 53213 - Fax +39 0431 522805  
[www.oblonautica.com](http://www.oblonautica.com) - [info@oblonautica.com](mailto:info@oblonautica.com)

## **Oblò srl - Divisione nautica**

### **Uffici Commerciali:**

Tel. +39 0421 244378  
Fax +39 0421 245644  
e-mail: [p.molent@italianasaldature.it](mailto:p.molent@italianasaldature.it)

